

# DIAMOND ANTENNA

*Product Catalog*

SWR & POWER METER

S.W.R

1.5

2

3

4

5

10

50

100

150

200

BY DIAMOND

POWER

0.5

1

2

3

4

5

DIAMOND  
ANTENNA

METER ADJUST

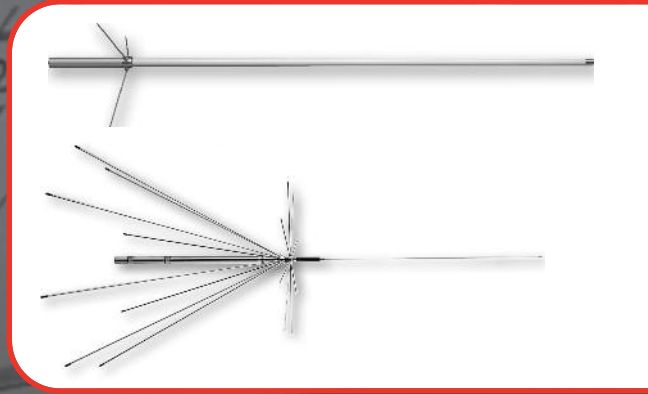

*The Standard By Which All Others Are Judged*

# DIAMOND ANTENNA



Merit  
W6NQ



Wayne  
KK4BUJ



Denise  
KK4BUK



Gary  
K6CAQ



Tod  
KB6TOD



Breanna  
KK4BUL



Brian  
KJ6YRL

At Diamond Antenna we take tremendous pride in our product and our customer service. We know our product is the best money can buy, and with purchasing a Diamond Antenna you are also purchasing the care and customer service that comes along with it.

Our product department is constantly going through every batch of antennas and thoroughly checking every inch to make sure that the Diamond Antenna you purchase will out perform and outlast the competition.

All Diamond Antennas are factory pretuned to give the best VSWR, No additional tuning required unless otherwise noted.

For all questions, comments, or concerns please contact us:  
ph - 770-614-7443    fx - 770-614-7480    email - [diamond@rfparts.com](mailto:diamond@rfparts.com)  
[www.diamondantenna.net](http://www.diamondantenna.net)    [facebook.com/diamondantenna](https://www.facebook.com/diamondantenna)

Diamond Antennas are available through authorized dealers.

And are distributed by the Diamond Antenna division of RF Parts Company - 435 S. Pacific St. - San Marcos, CA 92078

## One Year Limited Warranty

One year against manufacturing defects in material & workmanship.

The Diamond Antenna Division of RF Parts Co. will repair or replace, at its option, products it deems covered by Limited Warranty.

Products damaged due to misuse, improper tuning or installation, or freight handling are not covered by our Limited Warranty.

Contact the customer service department for Return Authorization number at 770-614-7443.

## Merchandise Return

Items returned for warranty repair must have copy of original purchase receipt and be shipped insured & prepaid to the address listed on back of catalog.

Return Authorization number must be obtained and written on outside of returned package.

Fiberglass antennas must be carefully packaged to protect their surfaces from scratches and abrasions.

Wrap metal ends of each antenna section to insure against shipping damage to fiberglass.

DO NOT SEND MOUNTING HARDWARE. Loose hardware causes damage to fiberglass sections.

Contact the customer service department for Return Authorization and questions pertaining to returns. 770-614-7443.

Diamond® and SUPER GAINER® are registered trademarks of Dai-ichi Denpa Kogyo Co., Ltd. Tokyo, Japan ©2013 RF Parts. All rights reserved.

# DIAMOND ANTENNA

**Copied By Many • Equalled By None!**

## Table of Contents

<b>Base Station Antennas</b>	Pg. 4-10	<b>Mobile Antenna Mounts</b>	Pg. 22-25
Monoband	Pg. 5	Heavy Duty	Pg. 22
Dualband	Pg. 6	Medium Duty	Pg. 23
Triband	Pg. 7	Deluxe Luggage Carrier	Pg. 23
Discone	Pg. 7	Mirror & Luggage	Pg. 23
Multiband	Pg. 8-9	Specialty Mounts	Pg. 24
HF, 6m, and Wire Dipoles	Pg. 8-9	Magnet Mounts	Pg. 25
Yagi, and Beam	Pg. 10		
<b>Mobile Antennas</b>	Pg. 11-18	<b>Duplexers &amp; Triplexers</b>	Pg. 26
Monoband	Pg. 12	<b>Power &amp; SWR Meters</b>	Pg. 27
Dualband	Pg. 13		
Mag/Antenna Combos	Pg. 15	<b>Power Supplies</b>	Pg. 28
Triband	Pg. 15		
Quad/Multiband	Pg. 16-17	<b>Accessories</b>	Pg. 29-30
HF-VHF	Pg. 16-17	Dummy Loads	Pg. 29
Handheld HT	Pg. 18	Through Window/Door	Pg. 29
<b>Cable Assemblies &amp; Adapters</b>	Pg. 19	Assembly	Pg. 29
		Heavy Duty Coax Switches	Pg. 29
<b>Commercial Antennas</b>	Pg. 20	Lightning/Surge Protection	Pg. 30
<b>Mount Brackets &amp; Antenna Masts</b>	Pg. 20	<b>Radiation Patterns</b>	Pg. 30
<b>Mobile Installation Ideas</b>	Pg. 21	<b>Important Info</b>	Pg. 30-31
		<b>More Photos</b>	Pg. 31

Any tampering, cutting or attempted adjustment of the antenna beyond our recommendations may void all warranty.  
If you have any questions, please call Diamond Customer Service Department at 770-614-7443

For More Technical information, radiation patterns, or installation instructions  
please visit [www.diamondantenna.net](http://www.diamondantenna.net)

# Base Station Antennas

Diamond Antennas' base station antennas are in a class of their own. For decades they have been tested, tortured, and put through the worst conditions possible. And in the end, you have a product that stands head and shoulders above the rest.

Our antennas are constructed using heavy-duty fiberglass radomes, or heavy-duty aluminum sections, making Diamond Antennas the toughest antennas on the market.

Wherever you live, whatever the conditions, a Diamond Antenna is the best choice.

## The X700HNA Base Station Repeater Antenna

### X700HNA Special Features:

- Heavy duty fiberglass radomes
- Four section assembly
- Overlapping outer shells for added strength
- Stainless steel mounting hardware and radials
- Strong waterproof joint couplings
- Type-N cable connection
- Wideband performance
- Highest gain Dual-band Base Antenna!

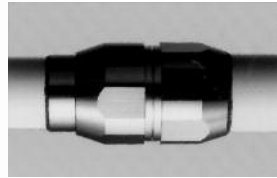

Strong waterproof joint couplings



Coax connection at base end



Heavy duty base/radial assembly

## Base Station Antennas

*Monoband Antennas*

*Pg. 5*

*Dualband Antennas*

*Pg. 6*

*Triband, Discone Antennas*

*Pg. 7*

*Multiband, HF, and 6m Antennas*

*Pg. 8-9*

*Wire Dipole Antennas*

*Pg. 9*

*Yagi Beam Antennas*

*Pg. 10*

# Monoband Base Antennas

Model	Bands	Gain/dBi	Max Pwr. Rating	Wind Rating	Height	Conn.	Element Phasing	Notes
CP22E	2m	6.5	200	70	8.9'	UHF	2-5/8λ	A
F22A	2m	6.7	200	112	10.5'	UHF	2-7/8λ	
F23H	144-174	7.8	350	90	15'	UHF	3-5/8λ	B, C
F718A	70cm	11.5	250	90	15'	N	18-1/2λ Coaxial Element Antenna.	
F1230A II	1.2GHz	13.8	100	112	12'	N	14-5/8λ	
F2405L	2400 MHz	5	10	-	23"	N	1/2λ 6 Element	
F2407L	2400 MHz	7	10	-	28"	N	1/2λ 8 Element	
F2409L	2400 MHz	9	10	-	35"	N	1/2λ 12 Element	
G200	2400 MHz	11	10	-	58"	N	1/2λ 19 Element	

**NOTES:**

A. Heavy-duty Aluminum. B. High Power C. Tunable 144-174 with cutting chart.

**Tip:** For multiple section base antennas, elements can shift during shipping. Lightly tap bottom of fiberglass on the ground to slide element back down to workable area.

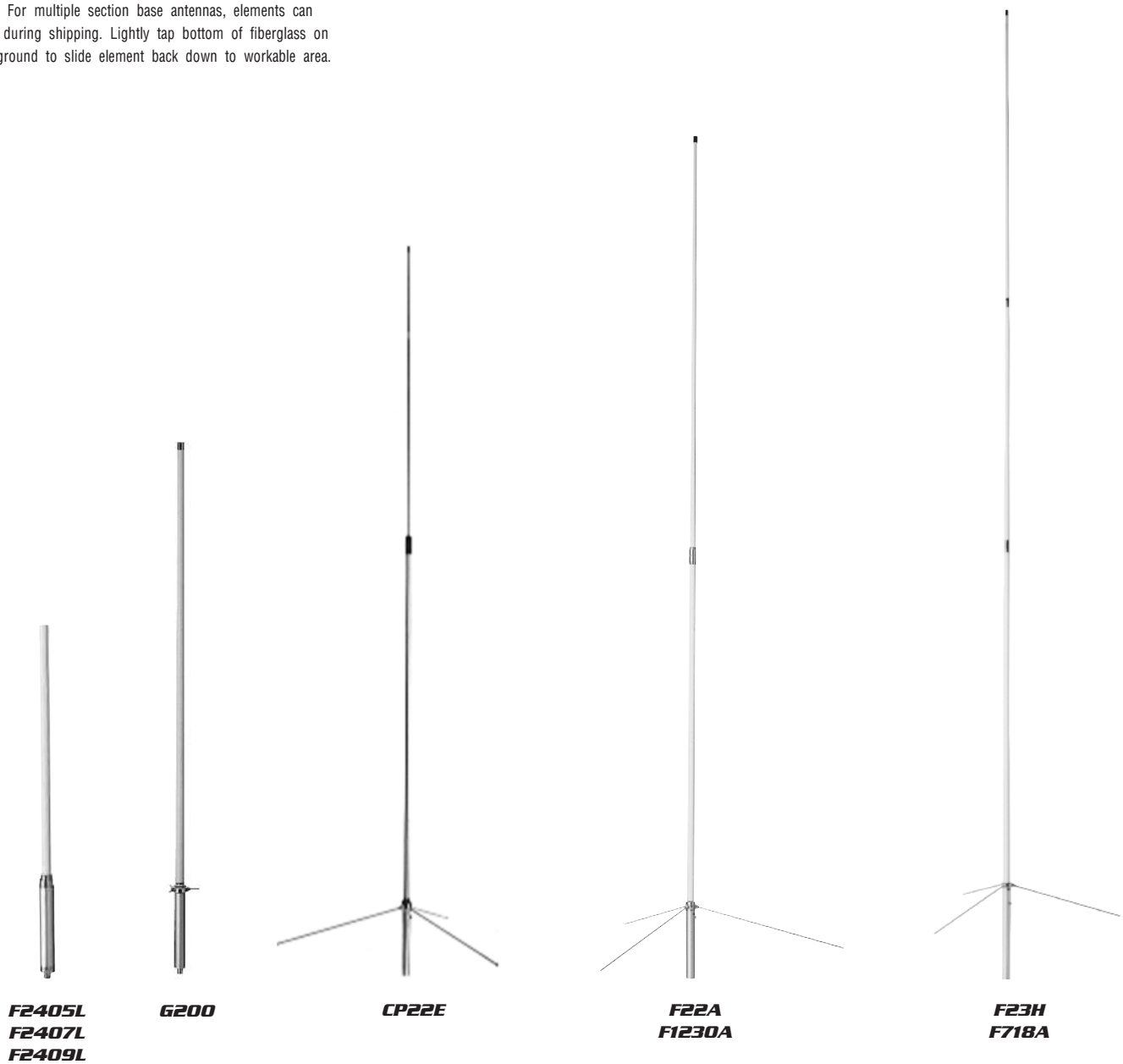

# Dualband Base Antennas

Model	Bands	Gain/dBi	Max Pwr. Rating	Wind Rating	Height (feet)	Conn.	Element Phasing	Notes
X30A	2m/70cm	3.0/5.5	150	135	4.5	UHF	2m: 1-1/2λ; 70cm: 2-5/8λ	
X50A	2m/70cm	4.5/7.2	200	135	5.6	UHF	2m: 3-1/4λ; 70cm: 3-5/8λ	
X50NA	2m/70cm	4.5/7.2	200	135	5.6	N	2m: 3-1/4λ; 70cm: 3-5/8λ.repeater version	B
X200A	2m/70cm	6.0/8.0	200	112	8.3	UHF	2m: 2-5/8λ; 70cm: 4-5/8λ	
X300A	2m/70cm	6.5/9.0	200	112	10	UHF	2m: 2-5/8λ; 70cm: 5-5/8λ	
X300NA	2m/70cm	6.5/9.0	200	112	10	N	2m: 2-5/8λ; 70cm: 5-5/8λ	
X510HDM	2m/70cm	8.3/11.7	330/250	90	17.2	UHF	2m: 3-5/8λ; 70cm: 8-5/8λ	A
X510HDN	2m/70cm	8.3/11.7	330/250	90	17.2	N	2m: 3-5/8λ; 70cm: 8-5/8λ	A, B
X510NJ	144-147/430-440	8.3/11.7	200	90	17.2	N	Optimized 143.5-146.5/428-442 MHz	
X700HNA	2m/70cm	9.3/13.0	200	90	24	N	2m: 4-5/8λ; 70cm: 11-5/8λ	B

**NOTES:**

A. High Power. B. Repeater Version (for repeater use, derate by 50% )

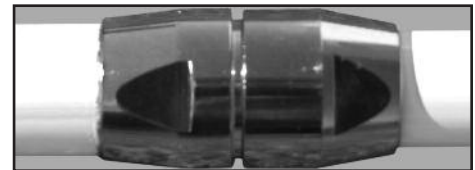

Heavy-Duty Joint Coupling



**X700HNA**



**X510HDM  
X510HDN  
X510NJ**



**X300A  
X300NA**



**X200A**



**X50A  
X50NA  
X30A**

# Triband, Discone Base Antennas

Model	Bands	Gain/dBi	Max Pwr. Rating	Wind Rating	Height (feet)	Conn.	Element Phasing	Notes
X3200A	2m/1-1/4m/70cm	6.0/7.8/8.0	100/200	112	10.5	UHF	2m: 3/4λ; 1-1/4m: 3-5/8λ, 70cm: 3-5/8λ	C
X6000A	2m/70cm/23cm	6.5/9/10	100/60	112	10.5	N	2m: 2-5/8λ; 70cm: 5-5/8λ, 23cm: 6-5/8λ	
V2000A	6m/2m/70cm	2.1/6.2/8.4	150	110	8.3	UHF	6m: 1/2λ; 2m: 2-5/8λ; 70cm: 4-5/8λ	B, D
D130J	25-1300 MHz	2 dBi nom.	200	90	5.6	UHF	Wideband Discone	A, E
D130NJ	25-1300 MHz	2 dBi nom.	200	90	5.6	N	Wideband Discone	A, E
D3000N	25-3000 MHz	2 dBi nom.	200	90	5.6	N	Wideband Discone	A, E

**NOTES:**

A. Adjustable 50-54MHz. B. 1/4λ rated in dBi C. 2m: 146-148MHz D. 6m: 52-54MHz E. 144MHz up: 200 watts, 6m: 20watts FM, 50 watts PEP

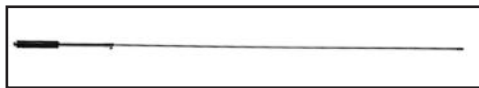

V2000A 6m Counterpoise Radial  
Adjustable 52-54Mhz (FM Only)



**D130J**  
**D130NJ**  
**D3000N**

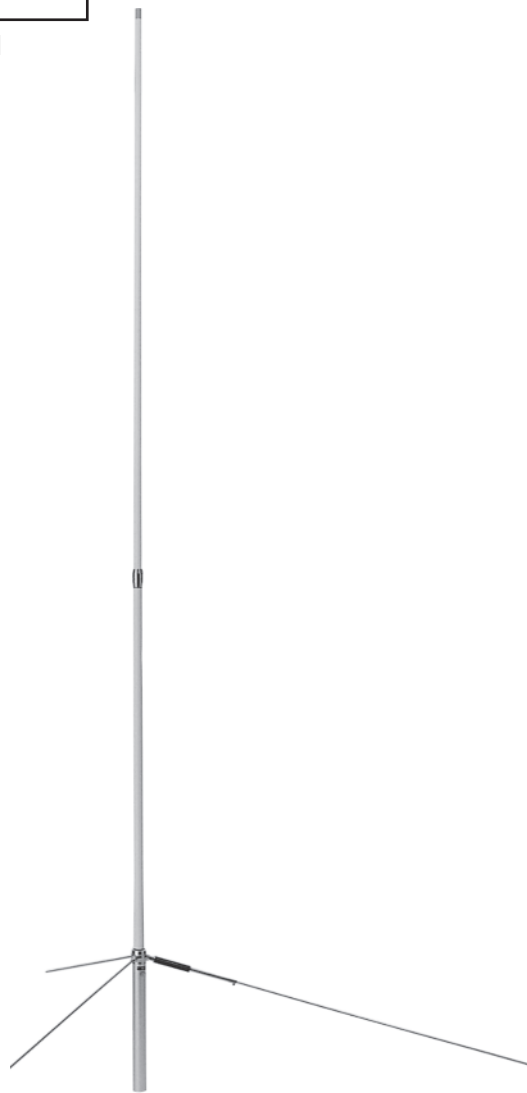

**V2000A**



**X3200A**  
**X6000A**

# Multiband, and HF Antennas

Model	Bands	Gain/dB	Max Pwr. Rating	Wind Rating	Height (feet)	Conn.	Element Phasing
BB7V	2-30 MHz	-	250	80	5/22	UHF	2-30MHz (tuner required) no radial vertical
CP-5H	40m/20m/15m/ 10m/6m	-	200/400/400 500/500 SSB	80	11.8	UHF	5 band trapped vertical antenna with trapped "counterpoise" radial elements
CP6AR	75m/40m/20m/ 15m/10m/6m	-	200w P.E.P.	80	15.1	UHF	6 band trapped vertical antenna with trapped "counterpoise" radial elements

## BB7V Multiband Vertical Antenna

Diamond's **BB7V** multiband vertical antenna provides coverage from 2 MHz to 30 MHz without radials. The BB7V has 6 telescoping sections that nest in each other with a collapsed length of 5 feet and extends to a length of 22 feet when fully deployed. These sections are self locking (no hardware to lose) and can be raised or lowered in less than a minute. For permanent use, each section can be locked in place with a single screw. The extreme ease of raising and lowering this 4.5 pound antenna will make it a favorite for those who have antenna restrictions or travelers wanting a quick and easy wide band antenna solution. The BB7V is a very slim, low profile antenna.

**Note:**  
The BB7V requires an antenna tuner for best performance.



## CP6AR Multiband Trap Vertical Antennas

Diamond's **CP Series** vertical antennas with trap radials are light weight antennas, which makes them very manageable during the installation process and will allow for a simple mast solution. The radials can be mounted 360 degrees around the antenna or concentrated on one side if you need to mount it close to a structure.

Because of its light weight and the option of concentrating radials to one side, the CP Series antennas could be used in an antenna restricted situation where the mast was lowered on its side during daylight, and raised while operating during the evening.

### Special Features:

- Compact size
- Heavy-duty aluminum sections
- Easy Assembly
- No additional ground radials required
- Mounting hardware included

**CP-6AR: Six Band**  
75m, 40m, 20m, 15m,  
10m, 6m

**CP-5H: Five Band**  
40m, 20m, 15m, 10m, 6m

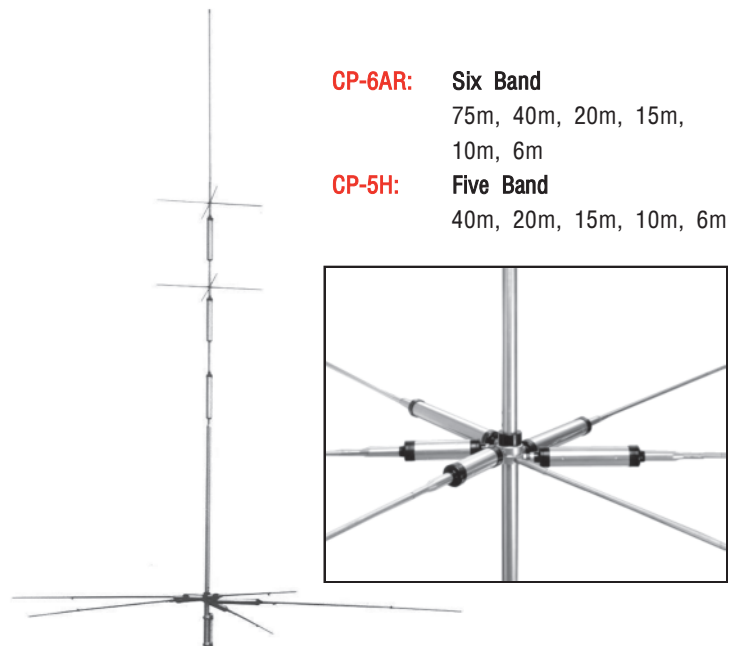



# Multiband, HF, and 6m Antennas, and Wire Dipole Antennas

Model	Bands	Gain/dBi	Max Pwr. Rating	Wind Rating	Height (feet)	Conn.	Element Phasing	Notes
CP62	6m(50MHz)	5.5	500 SSB/200 FM	80	22	UHF	2-5/8λ, BW: 1.5MHz	A, B
CP610	6m(50MHz)/10m(28MHz)	5.5/3.4	500 SSB/200 FM	80	22	UHF	6m: 2-5/8λ; 10m: 5/8λ, 6m 50-53MHz	B, C
W-735	80m/40m	-	1.2kW P.E.P.	-	85.3	UHF		
W-8010	80m/40m/20m/ 15m/10m	-	1.2kW P.E.P.	-	63	UHF		

**NOTES:**  
A. Adjustable 50-54MHz. B. Heavy-duty aluminum C. 10m tunable

## CP610 Dualband 6m/10m Vertical Antenna

- Heavy-duty aluminum
- Overlapping outer shells for added strength
- Stainless steel hardware
- Wide band performance
- Highest gain
- High wind rating
- DC grounded

Frequency: 6m, 10m  
 Power: 500 watts SSB,  
 200 watts FM  
 Gain: 5.5 dB (6m)/3.4 dB (10m)  
 Impedance: 50 ohms  
 VSWR: 1.8:1 (Nominal)  
 Element Phasing: 6m: 2-5/8 wave  
 10m: 5/8 wave  
 Overall Length: 22' (6.7m)  
 Connector: SO239 female UHF  
 Max Wind Rating: 80 mph (no ice)  
 Mast Diameter Acceptance: 1.2" - 2.4"



**Note:**  
CP62 is identical, just without 10m trap coil.

## W-8010, W-735 HF Wire Dipole Antennas

- The W-Series antennas are very easy to assemble. With stranded plastic coated hardened wire with low stretch ratio.
- Adjustment elements are provided to adjust each band without affecting the rest of the bands.
- A completely molded wideband balun enables perfect weather proof performance.
- W-8010 can be tuned to 75m



**Note:**  
Cutting adjustment element will raise resonant frequency.

# Yagi, and Beam Antennas

Model	Bands	Gain/dBi	Max Pwr. Rating	Wind Rating	Length (inches)	Conn.	Element Phasing	Notes
A502HB	6m 50-54MHz	6.3	400 (PEP)	80 MPH	37.5	UHF	2 Elements	
A144S5	2m 144-148MHz	9	100 (PEP)	80 MPH	37.5	UHF	5 Elements	
A144S10	2m 144-148MHz	11.6	100 (PEP)	80 MPH	83.9	UHF	10 Elements	
A430S10	430-440MHz	13	100 (PEP)	80 MPH	43	UHF	10 Elements	
A430S15	430-440MHz	14.8	100 (PEP)	80 MPH	89	UHF	15 Elements	
SS770R	2m/70cm	-	-	-	-	UHF	Phasing harness for stacking	A, B
<b>MOUNTING BRACKETS AND STACKING BOOMS</b>								
KB144	2m	-	-	-	-	-	Side mount boom	
KB430	430	-	-	-	-	-	Side mount boom	
SB144	2m	-	-	-	-	-	Dual antenna stacking boom	
SB430	430	-	-	-	-	-	Dual antenna stacking boom	
<b>NOTES:</b>								
A. 2m (144) / 70cm (430)    B. Input: SO-239/UHF (F) Output x2: PL-259/UHF (M)								

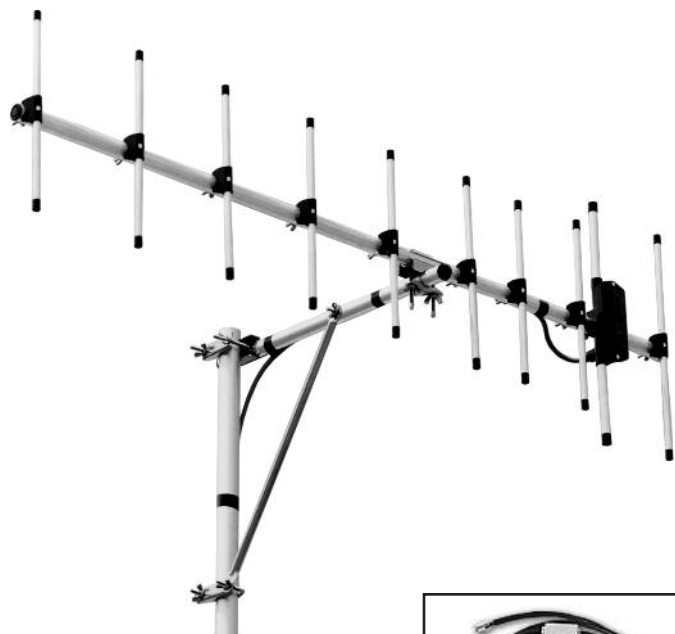

**A430S10**

A430S10 (above) and A430S15 (right) are shown mounted with side mount bracket KB430.

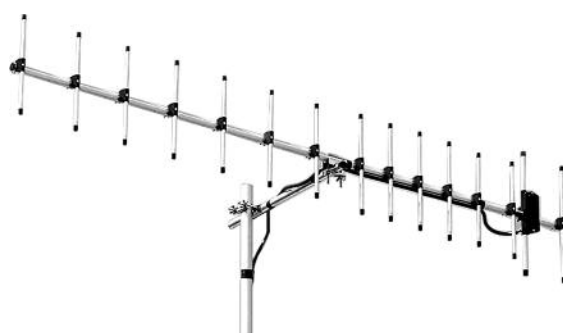

**A430S15**

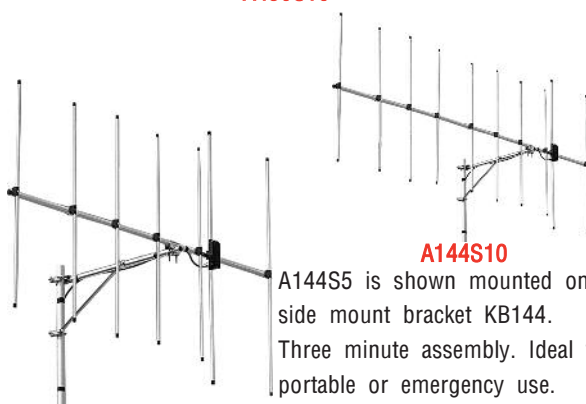

**A144S5**

**A144S10**

A144S5 is shown mounted on side mount bracket KB144. Three minute assembly. Ideal for portable or emergency use. A144S10 (shown above)



**SS770R**



**A430S10 x2**

Two A430S10s. Mounted with SB430 Stacking Boom, and SS770R Stacking Transformer.



**A502HB**

**A502HB Special Features:**

- High Gain
- Easy Assembly
- Great for base or portable use
- Quality Construction
- Factory adjusted - no tuning required.

## Mobile Antennas

Diamond Antennas' mobile antenna line is the best there is. Whether you are sitting in traffic talking with your buddies on 2m repeaters, or you scour the HF frequencies. Diamond Antenna has an antenna that fits your needs.

From high gain monobands, low profile mag mount/antenna combos, to quad bands and screwdrivers, there is no comparison when it comes to putting a Diamond Antenna on your vehicle.

With a wide range of different mounts; magnet mounts, trunk lid, motorized, luggage, and more! The mount and antenna possibilities are endless.

### **SD330 Specifications:**

- 3.5-30MHz or 7-50MHz
- 200 Watts (SSB)
- 2.5 Pounds
- UHF or 3/8x24 connector
- $1/4\lambda$  center loading
- Less than 2.0 VSWR
- 73" @ 3 MHz, 66" @ 28 MHz
- See Page 17 for more information

SD330 can be used from 3.5-30 MHz

Included is an optional element [OPE750] which allows the SD330 to be used from 7-50 MHz

The SD330 features a heavy-duty PL-259 base connector.

It is also available with a 3/8x24 base connector.

## **SD330 Screwdriver HF Antenna**



## Mobile Antennas

*Monoband Antennas*

*Pg. 12*

*Dualband Antennas*

*Pg. 13-14*

*Mag/antenna combos & Triband Antennas*

*Pg. 15*

*Quad/Multiband, HF-VHF Antennas*

*Pg. 16-17*

*Handheld HT Antennas*

*Pg. 18*

# Monoband Mobile Antennas

Model	Bands	Gain/dBi	Max Pwr. Rating (watts)	Impedance	Length (inches)	Conn.	Element Phasing	Notes
HF6CL	6m	2.15dBi	250 SSB-80 FM	50Ω	86.6	UHF	1/2λ. Radialess	A, B, E
HF10CL	10m	-	200 SSB-70 FM	50Ω	86.6	UHF	1/4λ. Radialess	A, B, E
HF20CL	20m	-	200 SSB-70 FM	50Ω	86.6	UHF	1/4λ. Radialess	A, B, E
HF40CL	40m	-	200 SSB-70 FM	50Ω	86.6	UHF	1/4λ. Radialess	A, B, E
HF80CL	80m	-	120 SSB-40 FM	50Ω	87.5	UHF	1/4λ. Radialess	A, B, E
NR22L	2m	6	100	50Ω	96.8	UHF	2-5/8λ. Radialess	B
HF6FX	6m	2.15	250	50Ω	44	UHF	1/4λ. Base loading	B
M285S	144-172	3.4	200	50Ω	52.4	UHF	5/8λ	C
M285SNMO	144-172	3.4	200	50Ω	52.4	NMO	5/8λ	C
M685S	6m	2.15	200	50Ω	52.4	UHF	1/4λ	B
M685SNMO	6m	2.15	200	50Ω	52.4	NMO	1/4λ	B
MG200	2400 MHz	7	10	50Ω	23.6	N	3-1/2λ. Coaxial dipole	D
NR124N	23cm	8.4	100	50Ω	25	N	4-5/8λ	
NR124NMO	23cm	8.4	100	50Ω	25	NMO	4-5/8λ	
NR140BNMO	222-225 Mhz	3.8	100	50Ω	36.2	NMO	1/2λ + 1/4λ	Black

**NOTES:**

A. HF Center Loading Series B. Not Recommended for Magnet Mounts C. Tunable w/ cutting chart D. FRP Outershell E. Heavy Duty Foldover



**HF CENTER LOADING SERIES**



**NR22L**



**HF6FX**



**M285S  
M285SNMO  
M685S  
M685SNMO**



**MG200**



**NR124N  
NR124NMO**



**NR140BNMO**



Heavy duty hex screw type foldover for larger mobile antennas

# Dualband Mobile Antennas

Model	Bands	Gain/dBi	Max Pwr. Rating	Height (inches)	Conn.	Element Phasing	Notes
CR270A	2m/70cm	2.15	50	17.3	UHF	2m: 2-1/2λ; 70cm: 2-5/8λ	B
NR72BNMO	2m/70cm	2.15/2.15	100	13.8	NMO	2m: 1/4λ; 70cm: 1/2λ	A, B Black
NR73BNMO	2m/70cm	2.15/5.3	100	33.5	NMO	2m: 1/2λ; 70cm: 2-5/8λ	Black
NR770HA	2m/70cm	3.0/5.5	200	38.2	UHF	2m: 1/2λ; 70cm: 2-5/8λ	
NR770HB	2m/70cm	3.0/5.5	200	38.2	UHF	2m: 1/2λ; 70cm: 2-5/8λ	Black
NR770HNMO	2m/70cm	3.0/5.5	200	40.2	NMO	2m: 1/2λ; 70cm: 2-5/8λ	
NR770HBNMO	2m/70cm	3.0/5.5	200	40.2	NMO	2m: 1/2λ; 70cm: 2-5/8λ	Black
NR7900A	2m/70cm	3.7/6.4	300/250	57	UHF	2m: 1/2λ + 1/4λ; 70cm: 3-5/8λ	A

**NOTES:**

A. Not recommended for Magnet Mount. B. Grounding required

\*More dualband antennas on pages 14-15e

CR270A base allows for easy removal and installation.



\*CR270A spring is not functional, and is for cosmetic purposes only.



**CR270A**



**NR72BNMO**



**NR73BNMO**



**NR770HA  
NR770HB  
NR770HNMO  
NR770HBNMO**



**NR7900A**

# Dualband Mobile Antennas

Model	Bands	Gain/dBi	Max Pwr. Rating	Height (inches)	Conn.	Element Phasing	Notes
AZ504FXH	2m/70cm	2.15	50	15.5	UHF	2m: $1/4\lambda$ ; 70cm: $1/2\lambda$	A, B
AZ504SP	2m/70cm	2.15	50	15.5	UHF	2m: $1/4\lambda$ ; 70cm: $1/2\lambda$	A, B, C
AZ507RSP	2m/70cm	2.15/4.9	50	27.5	UHF	2m: $1/2\lambda$ ; 70cm: $2-5/8\lambda$	C
SG7000A	2m/70cm	2.15/3.8	100	18.5	UHF	2m: $1/4\lambda$ ; 70cm: $3/8\lambda$	A, B
SG7500A	2m/70cm	3.5/6.0	150	40.6	UHF	2m: $1/2\lambda$ ; 70cm: $2-5/8\lambda$	
SG7500NMO	2m/70cm	3.5/6.0	150	41	NMO	2m: $1/2\lambda$ ; 70cm: $2-5/8\lambda$	
SG7900A	2m/70cm	5.0/7.6	150	62.2	UHF	2m: $2-1/4\lambda + 1-3/8\lambda$ ; 70cm: $3-5/8\lambda$	A
SG7900ANMO	2m/70cm	5.0/7.6	150	62.2	NMO	2m: $2-1/4\lambda + 1-3/8\lambda$ ; 70cm: $3-5/8\lambda$	A

**NOTES:**

A. Not recommended for Magnet Mount. B. Grounding required C. Spring above base



Super Gainer Series  
Fold Over



**SG7900A**  
**SG7900ANMO**



**SG7500A**  
**SG7500NMO**



**SG7000A**



**AZ507RSP**



**AZ504SP**



**AZ504FXH**

# Mag/Antenna Combos and Triband Mobile Antennas

Model	Bands	Gain/dBi	Max Pwr. Rating	Height (inches)	Conn.	Element Phasing	Notes
MR73SMA	2m/70cm	2.15/3.4	10	19.5	SMA (M)	2m: 1/4λ; 70cm: 5/8λ, Magnet	Black
MR73SJ		Same specs as MR73SA			SMA (F)	2m: 1/4λ; 70cm: 5/8λ, Magnet	Black
MR75SA	2m/70cm	2.15/3.4	35	20	SMA (M)	2m: 1/4λ; 70cm: 5/8λ, Magnet	Black
MR75SJ		Same specs as MR75SA			SMA (F)	2m: 1/4λ; 70cm: 5/8λ, Magnet	Black
MR77	2m/70cm	2.15/3.4	70	20	UHF	2m: 1/2λ; 70cm: 5/8λ, Magnet	Black
MR77SMA		Same Specs as MR77			SMA (M)	2m: 1/2λ; 70cm: 5/8λ, Magnet	Black
MR77SMAJ					SMA (F)	2m: 1/2λ; 70cm: 5/8λ, Magnet	Black
NR770HRKS	HRKS adhesive backed UHF (SO-239) mount with cable and NR770HB antenna. Package combo.						
NR2000NA	2m/70cm/23cm	3.15/6.3/9.7	100	39	N	2m: 1/2λ; 70cm: 2-5/8λ; 23cm: 5-5/8λ	
CR320A	2m/1-1/4m/70cm	2.15/3.8/5.5	200/200/100	37.4	UHF	2m: 1/4λ; 1-1/4m: 1/2λ; 70cm: 2-5/8λ	A,B, Black
CR320BNMO	2m/1-1/4m/70cm	2.15/3.8/5.5	200/200/100	37.4	NMO	2m: 1/4λ; 1-1/4m: 1/2λ; 70cm: 2-5/8λ	A,B, Black
CR627B	2m/70cm/6m	4.5/7.2/2.15	120	60	UHF	2m: 3-1/4λ; 70cm: 3-5/8λ; 6m: 1/4λ	A,B, Black
CR627BNMO	2m/70cm/6m	4.5/7.2/2.15	120	60	NMO	2m: 3-1/4λ; 70cm: 3-5/8λ; 6m: 1/4λ	A,B, Black

**NOTES:**

A. Not recommended for Magnet Mount. B. Grounding required



\*MR73 Adjustable hinge for multiple mounting options



\*MR75 Adjustable wing nut hinge for multiple mounting options



\*MR Series Mag Mount antennas also available in SMA Female to connect to your handheld



**MR735MA  
MR735J**



**MR755  
MR75J**



**MR77  
MR77SMA  
MR77SMAJ**



**NR770HRKS**



**NR2000NA**



**CR320A  
CR320BNMO**



**CR627B  
CR627BNMO**

# Quad / Multiband HF-VHF Mobile Antennas

Model	Bands	Gain/dBi	Max Pwr. Rating	Height (inches)	Conn.	Element Phasing	Notes
CR8900A	10m/6m/2m/70cm	2.15(10m/6m/2m) 5.5(70cm)	60	50	UHF	10m/6m: 1/4λ; 2m: 1/2λ; 70cm: 2-5/8λ	A, B, C
D220	100-1600 MHz	2.15(144/904/1200MHz) 5.5(440MHz)	50	35.5	UHF	Wideband Discone 144: 1/2λ, 440: 2-5/8λ	A
SD330	3-30 MHz	-	200 (SSB)	66-73	UHF or 3/8x24	1/4λ Center Loading	
HV7A	10m/6m/2m/70cm	2.15(10m/6m/2m) 5.5(70cm)	HF - 120 VHF - 200	54	UHF	10m/6m: 1/4λ; 2m: 1/2λ; 70cm: 2-5/8λ	A, B, D
<b>Optional loading coils for HV7A &amp; MV3A</b>							
HVC7				40m Loading Coil			
HVC14				20m Loading Coil			
HVC18				17m Loading Coil			
HVC21				15m Loading Coil			
<b>NOTES:</b>							
A. Not recommended for Magnet Mount. B. Grounding required C. 6m adjustable D. Heavy Duty Foldover							

## CR8900A

Antenna designed specifically for the Yaesu FT8900.

The CR8900A is pretuned to give best bandwidth and VSWR over the FM portions of 10m, 6m, 2m, and 70cm ham bands when mounted on the side of vehicle (i.e. trunk lid. Not recommended for through the roof mounts.) Use K400 or K600 series mounts.

Band: 10m/6m/2m/70cm  
Gain (dBi): 2.15(10m/6m/2m);  
5.5(70cm)  
Watts: 60  
Connector: UHF (PL-259)  
Height: 50"  
Element: 1/4λ-10/6; 1/2λ-2m;  
2-5/8λ-70cm

**Tip:** For best performance, make sure CR8900A is securely grounded to your vehicle before tuning the 6m and 10m portions of the antenna.

## D220 Mobile Scanner Antenna

The D220 mobile discone antenna offers outstanding broadband reception performance from 100MHz to 1600MHz.

The discone is vertically polarized and omnidirectional.

The upper element is tuned for the 144, 440, 902 and 1.2Ghz ham bands, and allows you to transmit at a maximum power level of 50 watts.

The antenna is recommended to be mounted on the Diamond K400/K600 series of mounts and will withstand wind speeds in excess of 100MPH.

**Assembles in just minutes!**

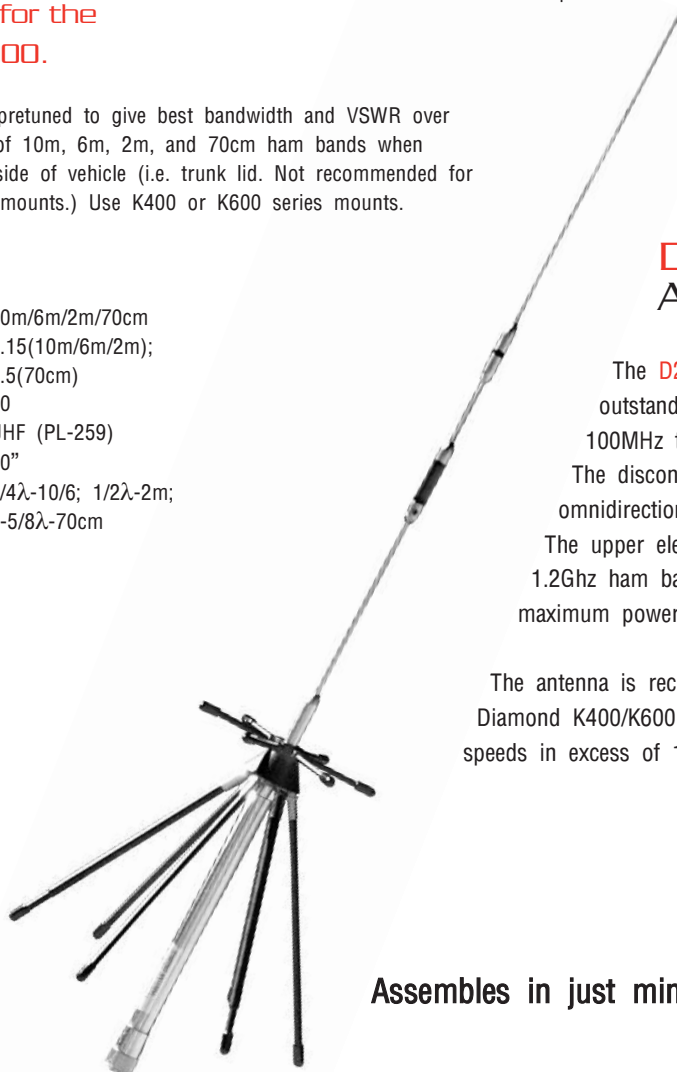



## Diamond HV7A Mobile Antenna System for HF/VHF Transceivers

The HV7A is a mobile antenna system with 5 band capability: 70cm, 2m, 6m, and 2 HF bands. Ideal for users of Icom IC706, IC7000 series and Yaesu FT100, FT857, FT8900 and similar transceivers. Addition of MX62M duplexer couples HF/VHF outputs to single coaxial connection. Unlike other multi-band antennas, the HV7A has no moving of connections, switches, jumpers, etc. Fold-over hinge allows for easy access into low over-head buildings.

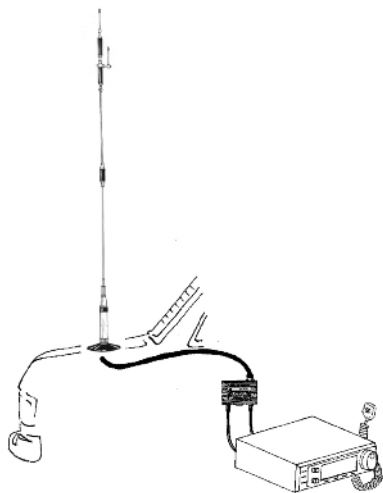

Bands Supplied: 10m/6m/2m/70cm  
 Optional Loading Coils: 40m/20m/17m/15m  
 Power, P.E.P.: HF 120w/VHF 200w  
 Mount Connection: UHF (SO-239)  
 Length: 54"  
 SWR: 1.5:1 nominal  
 Suggested Mount: K400 & K600 Series

\*For best performance antenna needs to be securely grounded.

\*Each Band may be independently tuned.

Popular HF/VHF Mobile Transceivers:  
 i.e. ICOM IC706 Series & Yaesu FT100

(Or combine your existing VHF/UHF & HF Equipment)



Optional HF Loading Coils



HV7A top section with optional loading coil attached

## SD330 / SD330-3/8 Screwdriver Antenna

The SD330 can be used from 3.5-30 MHz. If using element OPE750 (included) instead of original element, it can be used from 7-50 MHz.

OPE750 element is 17" shorter than original. To change element, you only need to loosen one set screw.

The SD330 uses the car body for its ground. The bracket and the car body need to be well grounded.

Recommend using the Diamond K400 series mounts.

Band:	3-30 MHz	Height:	66" @ 28 MHz	Height w/ OPE750:	
	7-50 MHz with OPE750		73" @ 3 MHz		49" @ 50 MHz
Watts:	200				56" @ 7 MHz
Connector:	SD330: UHF (PL-259)	Element:	1/4λ Center Loading		
	SD330-3/8: 3/8-24	VSWR:	Less than 2.0		

\*Tuner is not included



Power supply voltage & current: DC 12V 100mA

The SD330 includes cigarette lighter adapter for the up and down movement switch.

Up - down time: Approximately 50 seconds (3-30MHz)  
 Approximately 20 seconds (7-30MHz)

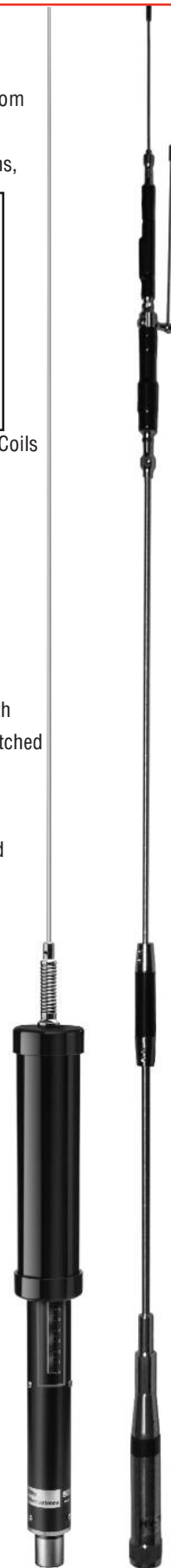

# Handheld HT Antennas

Model	Bands	Gain (relative)	Power Rating	Length (inches)	Conn.	Description
RH205	2m	+9 dB	10	9.1 / 52.8	BNC	1/4λ Retracted / 5/8λ extended. 10 stage telescoping.
RH3	2m/70cm	-2 dB	10	1.75	BNC	"Black Bullet", + 120-900 receive, compact design.
RH519	2m/70cm	+3 dB	10	8	BNC	Flexible slim design
RH707	2m/70cm	+3 dB	10	8.25	BNC	Tilttable whip
RH789	VHF/UHF	+6/+9 dB	10	7.9 / 31.7	BNC	See Below
RH77CA	2m/70cm	+6 dB	10	15	BNC	High Gain + Receive to 900 MHz
RHF40	2m/70cm	+6 dB	10	16	BNC	High Gain + Receive to 900 MHz <b>Extremely Flexible.</b>
RHF10	2m/70cm	-	6	2.75	BNC	Air band 150/300/450/800/900 MHz (rec.)
RH951S	2m/70cm/23cm	+6 dB	10	14	BNC	High Gain Tri-band. Flexible slim design.
SRH229	222-900 MHz	+4 dB	10	13.75	SMA (M)	High Gain, Flexible Whip. <b>For ALINCO DJ-G29T</b>
SRH519	2m/70cm	+3 dB	10	7.75	SMA (M)	Flexible slim design
SRH789	VHF/UHF	+6/+9 dB	10	7.9 / 31.7	SMA (M)	See Below
SRH77CA	2m/70cm	+6 dB	10	15	SMA (M)	High Gain + Receive to 900 MHz
SRHF10	2m/70cm	-	6	2.75	SMA (M)	Air band 150/300/450/800/900 MHz (rec.)
SRH320A	2m/1-1/4m/70cm	+3 dB	10	13.75	SMA (M)	Tri-band, flexible slim design with SMA
SRH805	2m/70cm/23cm	-2 dB	10	1.75	SMA (M)	Tri-band compact design
SRH815	2m/70cm/23cm	+3 dB	10	6	SMA (M)	Tri-band, flexible slim design with SMA
SRH940	6m/2m/70cm	+3 dB	10	17.75	SMA (M)	Tri-band, High Gain
SRHF40	2m/70cm	+6 dB	10	16	SMA (M)	High Gain + Receive to 900 MHz <b>Extremely Flexible.</b>
SRH999	6m/2m/70cm/23cm	+4 dB	10	19.5	SMA (M)	Quadband High Gain
SRJF10	2m/70cm	-	6	2.75	SMA (F)	Air band 150/300/450/800/900 MHz (rec.)
SRJ77CA	2m/70cm	+6 dB	10	15	SMA (F)	High Gain + Receive to 900 MHz

### NOTES:

Rated against typical stock HT antennas (rated at 0dB) - WOUXON: The SRJ77CA & SRJF10 is specifically made for Wouxon and other SMA male radios

## RH789 & SRH789 HT Telescoping Antennas

95MHz to 1100MHz, AM/FM receiving (at full length), omnidirectional, telescoping, folds at base





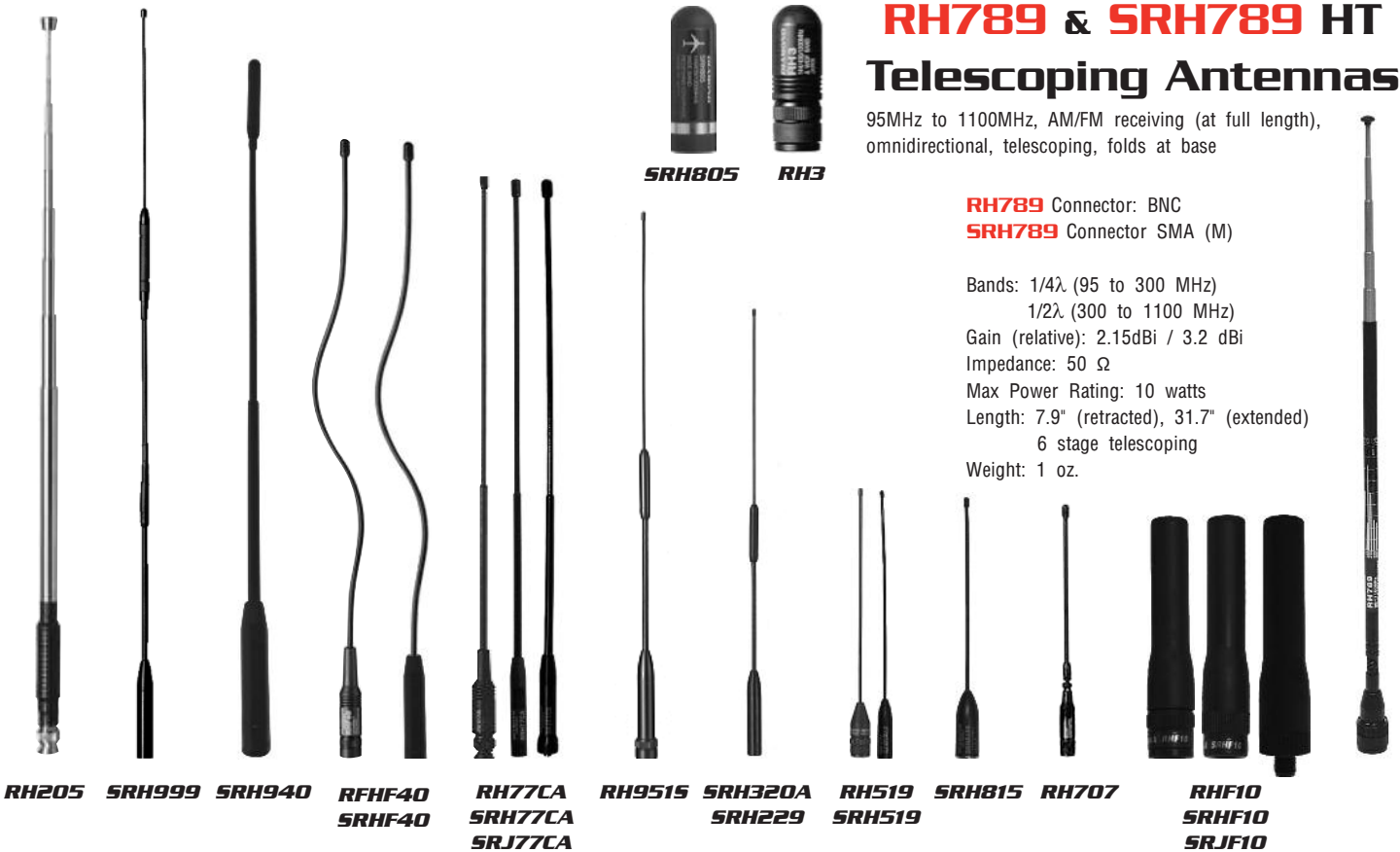



















**RH789** Connector: BNC  
**SRH789** Connector: SMA (M)

Bands: 1/4λ (95 to 300 MHz)  
 1/2λ (300 to 1100 MHz)  
 Gain (relative): 2.15dBi / 3.2 dBi  
 Impedance: 50 Ω  
 Max Power Rating: 10 watts  
 Length: 7.9" (retracted), 31.7" (extended)  
 6 stage telescoping  
 Weight: 1 oz.



# Cable Assemblies & Adapters

All Diamond C-Series Cables are made in the U.S.A. The C101, C211, and C213 fit all diamond mounts (except K600). Use of very flexible RG-316 Mil-spec Teflon® Coax. With SMA and mini-UHF connectors, wiring your antenna through tight body panels has never been easier. C101 & NMO, C213 & NMO, C101 3/8C Kit, and C211 all have a special low-loss PL-259 adapter included. C110BNC & C110SMA are great cable extensions for attaching your mobile antenna to your handheld radio!

	<p><b>C101</b> Ideal cable assembly for trunk mount/remote head installations. - 6.5' RG316 - SO-239 UHF base for antenna connection - mini-UHF with PL-259 Adapter</p>	
	<p><b>C213SMA</b> Fits all Diamond K-Series mounts (except K600M) - 13.5' RG316 - SO-239 UHF base for antenna connection - SMA Male with PL-259 Adapter</p>	
	<p><b>C101NMO</b> - 6.5' RG316 - NMO base for antenna connection - mini-UHF with PL-259 Adapter</p>	
	<p><b>C213SNMO</b> Fits all Diamond K-Series mounts (except K600, K540 and K550) - 13.5' RG316 - NMO base for antenna connection - SMA Male with PL-259 Adapter</p>	
	<p><b>C101-3/8C</b> Replacement cable assembly for K400-3/8C mobile antenna mount. - 6.5' RG316</p>	
	<p><b>C101-3/8C Kit</b> Upgrades any K400 mount to a K400-3/8C - Includes 3/8x24 hardware, C101-3/8C cable, and PL-259 adapter</p>	
	<p><b>C110</b> 10' RG-8X/Mini-8 coax - mini-UHF (M) to mini-UHF (F) Use with C101, C101NMO, K400C, K400CNMO, K400-3/8C, K412C. and K412CNMO</p>	
	<p><b>C211</b> Combination of C101, and C110 cable assemblies PL-259 Adapter included</p>	
	<p><b>C110SMA</b> 10' RG316 extension cable for any cable ending in mini-UHF (F) - mini-UHF (M) to SMA (M)</p>	
	<p><b>C110BNC</b> 10' RG-316 extension cable for any cable ending in mini-UHF (F) - mini-UHF (M) to BNC (M)</p>	
	<p><b>C104SMA</b> 4' extension cable for existing cables with PL-259 RG58/U cable, UHF Female (SO-239) to SMA Male</p>	
	<p><b>C105SMA</b> 5' extension cable for C101 RG58/U cable with mini-UHF Male to right angle SMA male</p>	

## Adapters



**BNCJ-SMAP**

For SMA equipped handhelds to use BNC antennas. Black, low profile.



**BNCP-SMAJ**

For BNC equipped handhelds to use SMA antennas. Black, low profile.



**DIA3824**

SO-239 to 3/8x24 adapter  
Adapts a SO-239 connector to a male or female 3/8x24 antenna. Comes with washer nut, and threadlock.



**RSA3474**

SMA Female to PL-259. Included in Diamond's S series mounts.



**RFU645**

Mini-UHF Male to PL-259. Included in Diamond's C series mounts

# Commercial Antennas Mount Brackets

Model	Bands	Gain/dBi	Max Pwr. Rating	Wind Rating	Height	Conn.	Element Phasing	Notes
F23H	144-174 MHz	7.8	350	90	15'	UHF	3-5/8λ	A, B
X50C2	146-155 / 450-465 MHz	4.5/7.2	200	135	5.6'	UHF / N	146MHz: 3-1/4λ; 450MHz: 3-5/8λ	C
BC103	143-176 MHz	2.5/3.2	300	135	4.1'	UHF	1/2λ-5/8λ; Radialess, Less than 2.0 VSWR	D
M285S	144-172 MHz	3.4	200	-	52.4"	UHF	5/8λ	B
M285SNMO	144-172 MHz	3.4	200	-	52.4"	NMO	5/8λ	B

**NOTES:**

A. High Power. B. Tunable with cutting chart C. X50C2 tuned for commercial freq. Available in UHF or Type N D. No Tuning Required

**Commercial Antennas:** High power antennas such as the F23H. And mobile antennas like the M285S and M285SNMO, include cutting charts, which allows you to tune the antenna into the commercial and marine band frequencies. The X50C2 is our standard X50, but it is factory tuned for commercial use. The BC103 is wideband and requires no tuning to work within the given frequencies!

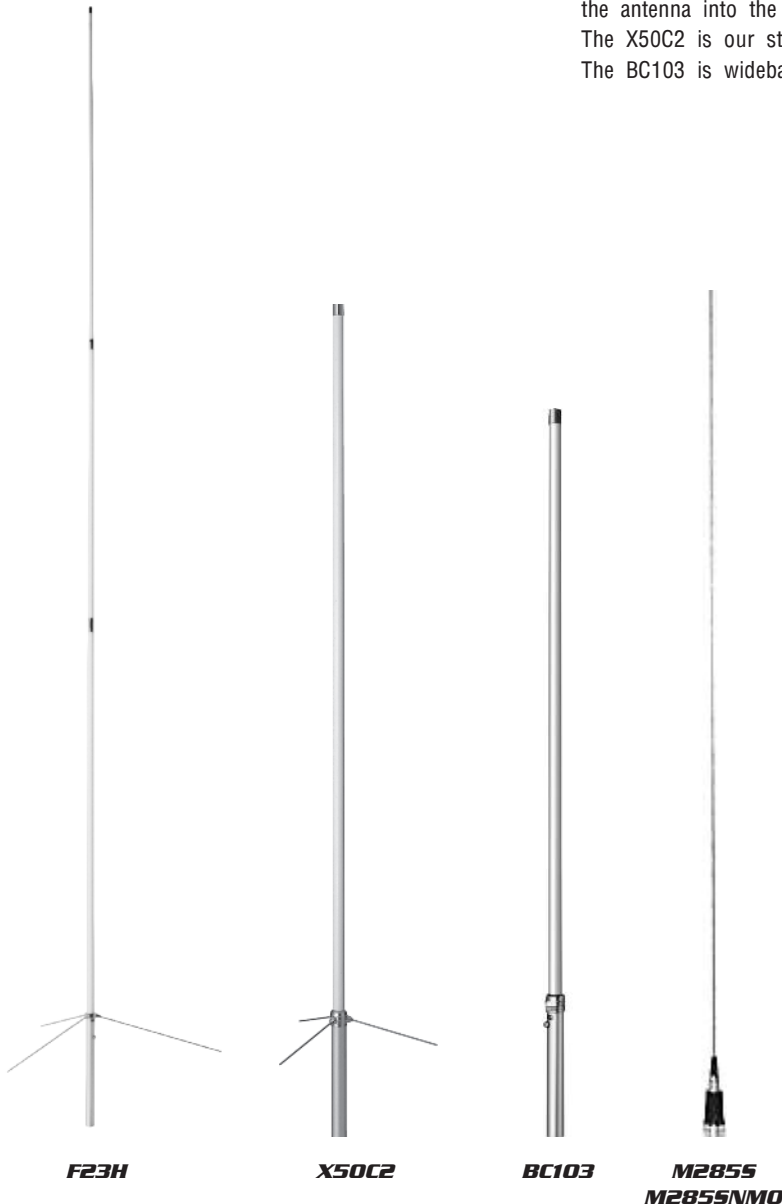

**S1 Mast Bracket:**

- Zinc Diecast
- Fits mast sizes of 1.2" to 2.4"
- Max antenna load must be less than 6.5' in total length
- Antenna must be 2.2 lbs and under in total weight



# Mobile Installation Ideas

Here is a few different examples of ways you can use Diamond Antenna Mounts and Antennas!



Don't have any room or a spot to mount on your truck? Here is a K400SNMO and an SG7900ANMO mounted to the tailgate of a Ford Ranger. (some mount modification may be required for this installation)

Whatever vehicle you have, Diamond Antenna can get a mount, and mobile antenna to fit your needs!

**Multiple Uses!** You can use the SMA from the S series mounts to plug your mobile antenna's coax directly into your handheld radio!



Need a heavy duty mount for your CB whip? The K400-3/8C or K400-3/8C2 is the perfect mount for you. Here is one mounted to the hatch of a Jeep Grand Cherokee 4x4. This mount will take all the abuse you can dish out on your next off-roading adventure!

The possibilities are endless!

Here is a K9000TM mounted with a SG7500 Series antenna. 20' of cable for the switch will make sure you have enough to get the switch right where you need it



Photo Courtesy: Kelley Miller, K5KTX



This SD330 is mounted on the trunk lip of a Dodge Challenger with a K400C mount. The rubber pad attached under the mount ensures there will be no paint scratched. With the radio mounted in the front of the vehicle a C110 was used to extend the cable to the front.

Need a slick low profile mount for your sweet ride? The K600 Series mount is the perfect low profile mount. Slim line design, and the angled washers give you up to 9° of adjustment for your antenna.



Travel the country a lot? Well check out this K400 holding one of Diamonds new HF Center Loading Series antennas on the bumper of this camper.\*



Photo Courtesy: Robert Pullman, KE5JJC

\*Although not a recommended mounting location for an antenna, this installation met the users expectations.

## K400 Series

### Heavy Duty Trunk Lid & Hatchback Mount

Diamond Antennas K400 mount is the strongest, most durable trunk lid & hatchback mount on the market. It is also the most universal mount, featuring a 2-axis adjustment, giving you the freedom to install it anywhere and allow antenna to still be vertical. The K400 features a rubber mounting pad, so you don't have to worry about it scratching or damaging your paint! 4 heavy duty set screws insure that once mounted, the K400 is going to be secure.

The K400 is available in whatever connection type you need: UHF, NMO, or even 3/8x24 guaranteeing that the K400 will be the last mount you ever purchase.



K400 Mount Only

Model	Base Connector	Cable	Cable Length (ft)	End Connector
K400	Mount Only			
K400C	SO-239 UHF	RG-316	6.5	Mini-UHF (F)
K400S	SO-239 UHF	RG-316	13.5	SMA (M)
K400CNMO	NMO	RG-316	6.5	Mini-UHF (F)
K400SNMO	NMO	RG-316	13.5	SMA (M)
K400-3/8C	3/8x24	RG-316	6.5	Mini-UHF (F)
K400-3/8C2	3/8x24	RG-316	13.5	Mini-UHF (F)

**NOTES:**

All RG-316 is Mil-spec Teflon® Coax..

K400 series (excluding K400 mount only) come with a PL-259 adapter for your radio.

**Don't have a mobile radio?** Use the SMA from the S series mounts to plug your mobile antenna's coax directly into your SMA handheld!



K400-3/8



K400-NMO



K400-UHF



Here is a K400-3/8C mounted on the back of a Jeep Wrangler 4x4. The K400-3/8C is the ideal mount for the Diamond SD330-3/8, Outbacker Perth, Tarheel II, OB Jr., and other medium weight antennas using 3/8x24 base.

**Power: 1KW; 1-30MHz**

\*Use K400-3/8C2 for front radio installation.

For K400-3/8C use C110 for front radio installation

## K600 Series

### Heavy Duty Variable Angle Trunk Mount



Diamond Antennas K600 is a deluxe, heavy duty trunk lip mount. It has a sleek aerodynamic design. Two angle washers at the base of the connector give you the freedom of a 0-9° angle of adjustment in any direction you need.

The K600 comes in two different versions:

**K600S**

Features:

- Stainless steel mount assembly
- SO-239 base connection
- Four set screws for secure mounting
- 13.5' RG-316 Mil-spec Teflon Coax
- SMA (M) end connection
- PL-259 adapter.

**K600M**

Features:

- Stainless steel mount assembly
- SO-239 base connection
- Four set screws for secure mounting
- 16.5' two-step cable assembly RG-188 & low loss 7mm 5D cable
- PL259 end connection

# Mobile Antenna Mounts

## K412 Series

### Medium Duty Trunk Lid & Hatchback Mount

The Diamond K412 Series mounts are medium duty trunk lid and hatchback mounts. They feature a three-axis adjustment for placement anywhere you need. If your antenna doesn't feature a fold over, then this is the mount for you. The wing nut allows you to use the mount as a fold over for ease in negotiating low overhead buildings and structures.

The K412 is compact and ideal for tight mounting options. 1.5 inch mounting width. Recommended for antennas under 45"



Model	Base Connector	Cable	Cable Length (ft)	End Connector
K412C	SO-239 UHF	RG-316	6.5	Mini-UHF (F)
K412S	SO-239 UHF	RG-316	13.5	SMA (M)
K412CNMO	NMO	RG-316	6.5	Mini-UHF (F)
K412SNMO	NMO	RG-316	13.5	SMA (M)

#### NOTES:

All RG-316 is Mil-spec Teflon® Coax.  
K412 series comes with a PL-259 adapter.



#### Both include:

- Allen wrenches
- Mounting hardware
- Adhesive cable holders

## K515 Series

### Deluxe Luggage Carrier Mount

Ideal for newer SUV designs

#### K515S

Features:

- Black finish
- 1.5 inch mounting width
- Two-axis adjustable
- Wing nut for fold-over
- SO-239 base connection
- 13.5 RG-316 Mil-spec Teflon Coax
- SMA (M) end connection
- PL-259 adapter.

#### K515SNMO

Features:

- Black finish
- 1.5 inch mounting width
- Two-axis adjustable
- Wing nut for fold-over
- NMO base connection
- 13.5 RG-316 Mil-spec Teflon Coax
- SMA (M) end connection
- PL-259 adapter.

## Mirror and Luggage Rack Mounts

#### K540

Deluxe, adjustable Mirror/Luggage Rack mount with the wing nut antenna fold over feature. Fits 1/2" to 7/8" tubing mirrors or utility racks. Black finish.

Recommended for lightweight to medium size antennas (up to 45")



#### K550 and K550L

Deluxe, adjustable Luggage Rack mount with wing nut antenna fold over feature. Ideal for minivan racks. Black finish. K550L for luggage racks over 2" in diameter

Recommended for lightweight and medium size antennas (up to 45")



#### CRM

Stainless Steel right angle mount with U-bolt. Recommended for:

- Motorhome ladders
- Luggage racks
- Balcony railings
- Lumber racks
- Pipe racks

\* Where mounting source does not provide adequate ground, use non-radial type antenna.



#### K540KM and K550KM:

Mount and cable combo, SO-239 UHF base with 16.5' RG58A/U cable ending in PL-259

# Specialty Antenna Mounts

## K9000 Series Motorized Mount



Raise and lower your antenna with a touch of a button with Diamond's **K9000** motorized mount.

**Available Options:**

- K9000TM:** Trunk Lip mount
- K9000LRM:** Luggage Rack Mount
- K9000LRMO:** Luggage Rack Mount, Oversize

**Specifications:**

- Accepts "Ground Independent" antennas up to 45" in length
- 0-90° Range. Operates from 12VDC with fused cigarette plug. Includes 20' cable to switch.
- Compatible with Diamond C-series SO-239 cable assemblies.
- Recommended antennas:  
AZ507RSP, NR770 Series, SG7500A,
- NMO compatible with custom NMO cable from Diamond Antenna



**Special Features:**

- The mount bracket has a spring-type back torque limiter which can prevent the antenna from rattling and protect the car and mount bracket.
- A protective rubber sheet is attached to K9000TM bracket which reduces possible discolorations or scratching of painted surfaces.
- The mount bracket is fully adjustable from angles 45-90°. You can choose from 7 levels of adjustment with the control knob (on side of motor drive).
- For simple wiring of motor drive, a cigar plug is included. Mounting bracket and base fitment assemblies are separate for easy angle adjustment.

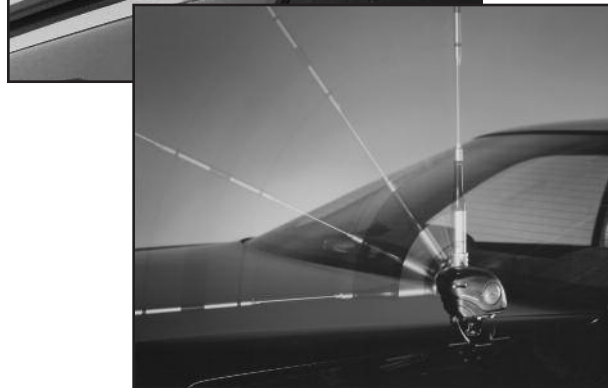

## HRKS Adhesive Backed Mount

3M Adhesive backed for flat surface installations including glass, fiberglass, and metal.

**Specifications:**

- SO-239 base connection
- Two-axis of adjustment
- Wing nut for fold-over
- 13.5 RG-316 Mil-spec Teflon Coax
- SMA (M) end connection
- PL-259 adapter.

**Recommended antennas:**

NR770HA, NR770HB,  
AZ507RSP, SG7500A



**Available Options:**

- HRKS:** Mount with cable assembly
- NR770HRKS:** Mount, cable assembly, and NR770HB 2m/70cm mobile antenna



# Magnet Mounts

## SPM Series

### Heavy-duty Magnet Mounts



SPM35

**Available Options:**

**SPM35:** SO-239 base, 13' 3.5D-2V coax & PL-259

**SPMNM0:** NMO base, 13' 3.5D-2V coax & PL-259

**DPK4-NM-N:** Type-N female base, 13' 3.5D-2V coax & Type-N Male

Diamond's SPM series magnet mounts are the toughest and most durable around. With a very strong magnet in a durable plastic case, THIS IS ONE TOUGH MAGNET MOUNT.

The SPM/DPK weighs in at 2.2 lbs, 4" diameter, and are rated 25-500 MHz. Available in SO-239, Type-N, and NMO connectors. Recommended for antennas up to 45".



SPMNM0



DPK4-NM-N

**Tip:** PL-259 and Type-N connectors can be disassembled to run the cable through tight holes during installation.



PL-259

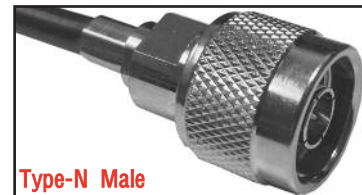

Type-N Male

## K702M

### Deluxe Magnet Mount

Deluxe low profile magnet mount. Combines the holding power of a magnet and a vacuum suction from specially designed base. For ease of removal, vacuum may be released by lifting tab (shown below).

Aerodynamic styling, large 6 3/8" diameter, 3/4" tall. Recommended for VHF/UHF antennas up to 50" in height. Includes a thin mylar protective sheet to enhance grip and protect paint.

**Cable:** 13' RG58A/U and PL-259



K702M

# Duplexers & Triplexers

Model	Port	Frequency MHz	Power Rating (ICAS)		Insertion Loss dB	Isolation dB	Mix Connection	Port Connections
MX37	LPF	1.6-470	100	100	.25	45	N-Jack (F)	PL 259 / 12" 5D cable N-Male / 12" 5D cable
	HPF	900-1300	50	50	.45	45		
MX214	LPF	140-250	150	300	.3	40	SO-239	PL-259 / No cable
	HPF	200-225	100	200	.4	40		
MX62M	LPF	1.6-56	200	600	.2	50	SO-239	PL 259 / 12" 5D cable
	HPF	76-470*	200	600	.3	50	SO-239	PL 259 / 12" 5D cable
MX72D	LPF	1.6-30	400	1 KW	.1	60	SO-239	PL 259 / No cable
		140-150	150	400	.1	60		
	HPF	400-460	100	250	.2	60		
MX72A		Same specifications as MX72N					N-Jack (F)	PL 259 / 12" 5D cable
MX72H		Same specifications as MX72N					SO-239	PL 259 / 12" 5D cable
MX72N	LPF	1.6-30	400	1 KW	.1	60	SO-239	PL 259 / 12" 5D cable
		140-150	150	400	.1	60		
	HPF	400-460	100	250	.1	60		
MX324	LPF	1.5-150	400	800	.3	40-50	SO-239	PL 259 / 12" 5D cable
	BPF	220-225	300	600	.4	40-50	SO-239	PL 259 / 12" 5D cable
	HPF	400-550	250	500	.4	40-50	SO-239	PL 259 / 12" 5D cable
MX610	LPF	1.3-30	200	300	.2	45	SO-239	PL 259 / 12" 5D cable
	HPF	49-470	200	600	.25	45	SO-239	PL 259 / 12" 5D cable
MX2000	LPF	1.6-60	400	800	.15	60	SO-239	PL 259 / 12" 5D cable
	BPF	110-170	400	800	.2	60		PL 259 / 12" 5D cable
	HPF	300-950	250	500	.25	60		PL 259 / 12" 5D cable
MX2000N	LPF	1.6-60	400	800	.15	60	SO-239	PL 259 / 12" 5D cable
	BPF	110-170	400	800	.2	60		PL 259 / 12" 5D cable
	HPF	300-950	250	500	.25	60		N-Male / 12" 5D cable
MX3000	LPF	1.6-160	400	800	.15	55	N Jack (F)	PL 259 / 12" 5D cable
	BPF	350-500	200	400	.25	55		PL 259 / 12" 5D cable
	HPF	850-1300	100	200	.3	55		N Male / 12" 5D cable
MX3000N	LPF	1.6-160	400	800	.2	55	N Jack (F)	PL 259 / 12" 5D cable
	BPF	350-500	200	400	.3	55		N Male / 12" 5D cable
	HPF	850-1300	100	200	.4	55		N Male / 12" 5D cable

NOTES: VSWR: 1.2:1 (nominal) Impedance: 50 ohm \*76-120 MHz Receive only

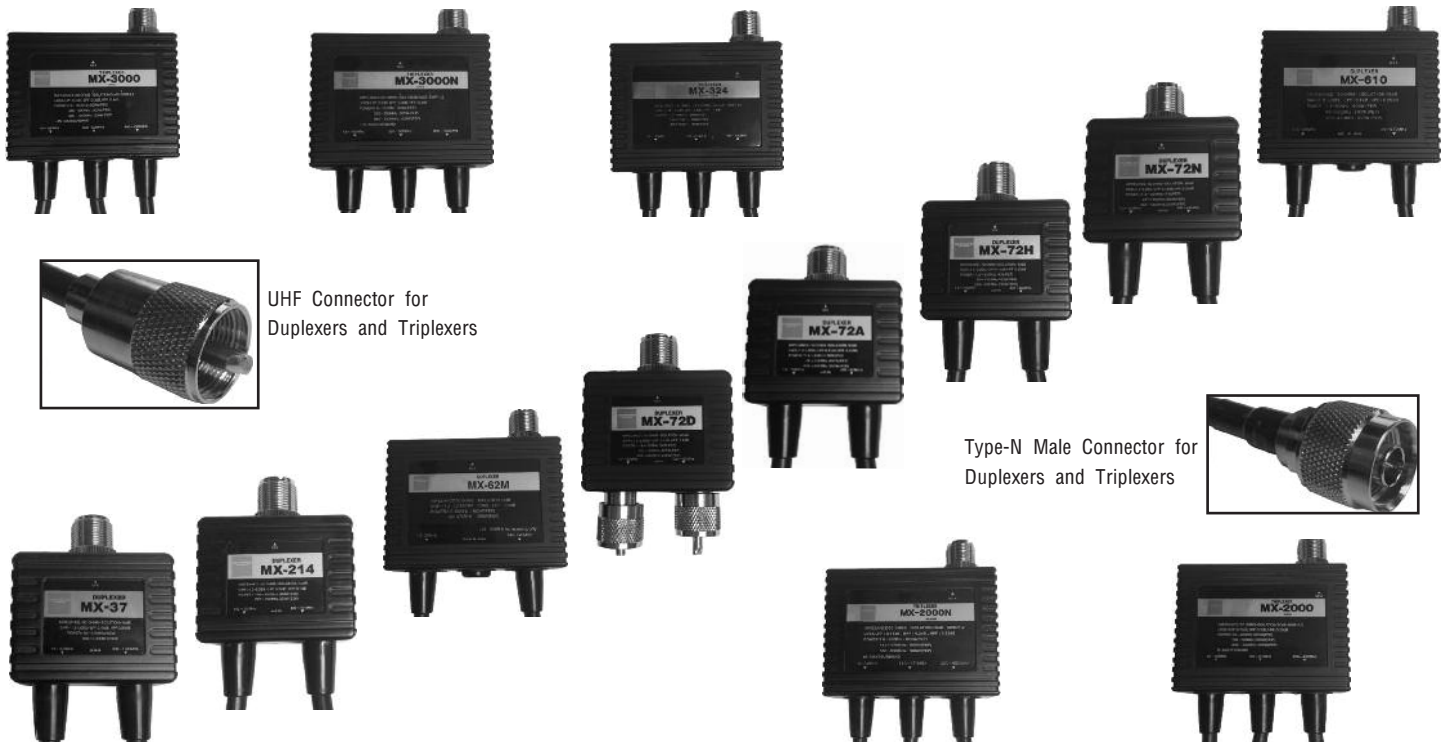

# Power and SWR Meters

Model	Frequency, MHz	Power Range	Min. Power for SWR Test	Conn.	Notes
SX100	1.6-60	30/300/3KW	20W	S0-239	
SX200	1.8-200	5/20/200	15W	S0-239	
SX400	140-525	5/20/200	15W	S0-239	
SX600	1.8-160/140-525	5/20/200	15W	S0-239	
SX1100	1.8-160/430-450/1240-1300	5/20/200	15W	HF-VHF: S0-239	UHF: Type-N(female) Connectors
SX20C	3.5-30/50-54/130-150	30/300	5W	S0-239	
SX40C	144-470	30/300	5W	S0-239	220 MHz uses a correction factor.
SX240C	1.8-54/140-470	30/300/3KW	10W	S0-239	220 MHz uses a correction factor. 3KW+HF only.

SX20C and SX40C- 5W minimum, 10W for best accuracy

Diamond Antenna models SX-100 through SX1100 meters measure forward and reflected power and VSWR. Compact size makes meter useful for testing both base and mobile installations. Illuminated meter, switchable r.m.s. or peak power. SX600 and SX1100 have two directional couplers selectable by switch with LED indicators for coupler I.D. of two transceivers. 12VDC @ 50mA is required if illuminated display is desired.

SX Meter Dimensions: 6"W x 2"H x 4"D, 2 lbs.



## SX20C, SX40C, SX240C SWR / Power Meters

The SX20C, SX40C, and SX240C are compact SWR-power meters, featuring cross needle design for measuring SWR and output power simultaneously.

Compact size makes them very useful for testing mobile as well as base station installation. The SX240C also features a 3KW power range for HF use.



SX240C



SX20C/SX40C

# Switching Mode DC Power Supply

## GZV4000 AND GZV6000



### GZV4000 (40 Amp)

#### GZV4000 Features:

- Weight: 8 lbs.
- Size 8.25" x 4.5" x 13"
- 40 Amp continuous rating, 100% duty cycle.
- Variable Voltage Control 5-15 VDC
- Accepts 95-145 VAC input
- Overload & short-circuit protection with Voltage Foldback at approximately 42 Amp (see below for additional features)



#### Did you know?:

GZV4000 is also available in 220 Volt only version. (GZV4000-220)

### GZV6000 (60 Amp)

#### GZV6000 Features:

- Weight: 12.8 lbs.
- Size 8.25" x 4.5" x 16"
- 60 Amp continuous rating, 100% duty cycle.
- Variable Voltage Control 1-15 VDC
- Overload & short-circuit protection with Voltage Foldback at approximately 62 Amp
- 100-240 VAC 50-60 Hzinput



#### PC3:

3 meter (9.8') power cable with T connector (for VHF/UHF mobile rigs), 20amp fuse, 14 guage wire.



#### Both Feature:

- Voltage Control Knob has center detent at 13.5 VDC
- Over Temperature Protection
- Meter Selector allows monitoring of voltage & current
- Built in 8Ω, .5W speaker
- Access to front panel DC terminals and cigarette lighter jack; high current terminals on rear panel
- Circuitry yields high RFI protection from external sources
- AC line filter for EMI protection
- Standard 3-wire heavy duty line cord
- Power indicator & overload indicator
- Ripple & Noise less than 8 mV r.m.s.
- 1 year limited warranty

# Accessories

## DL30

### Compact Dummy Load



**DL30A:**

- DC - 500 MHz
- 15 Watts continuous, 100 watts peak (intermittent)
- Connector: PL-259 (UHF Male)
- Impedance: 50Ω
- VSWR: 1.15
- 1.18" diameter x 2.95" length



**DL30N:**

- DC - 500 MHz
- 15 Watts continuous, 100 watts peak (intermittent)
- Connector: Type-N Male
- Impedance: 50Ω
- VSWR: 1.15
- 1.18" diameter x 2.95" length

## MGC50

### Through Window/Door Assembly

**MGC50 Specifications:**

- DC - 1500 MHz
- Power: HF to 50MHz: 150W (SSB), 50W(FM/CW)  
144MHz: 40W (FM), 440MHz:30W (FM)  
1200MHz: 10W (FM)
- Length: 19.7" between the connectors
- Weight: 3.6 oz.
- Connector: UHF Female to UHF Female
- Impedance: 50Ω

- VSWR: HF up to 500MHz: less than 1.2  
500 to 1000MHz: Less than 1.3  
Up to 1000MHz: Less than 2.0  
1200MHz: Less than 1.7

- Ins. Loss: 144MHz: Less than 0.3dB  
440MHz: Less than 0.6dB  
1200MHz: Less than 1.6dB

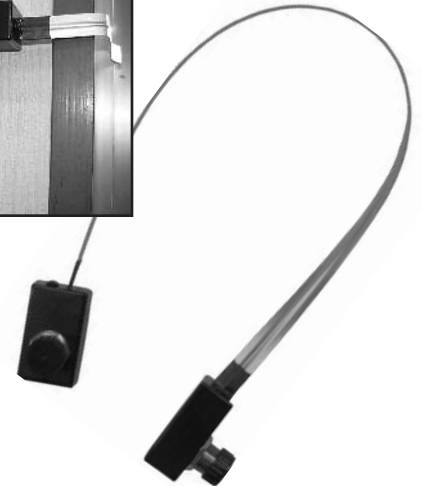

## CX Series

### Heavy Duty Wideband Coax Switches



CX310A



CX210A and CX210N



CX210N Connectors



CX210A/CX310A Connectors

**CX210A:**

- DC-1000MHz
- 1.5KW
- SO-239 (UHF Female)

**CX310A:**

- DC-800MHz
- 1.5KW: DC-30MHz  
1KW: 30-150MHz  
500W: 150-800MHz
- SO-239 (UHF Female)

**CX210N:**

- DC-1500MHz
- 1.5KW
- Type-N Female

# Lightning Surge Protectors

Model	Frequency	SWR	Insertion Loss	Max Pwr. Rating	Connector	I.W.D.V.	I.W.D.C.	I.W.R.D.C.	Insulating Resistance DC100v	Imped
SP1000	DC-1000 MHz	< 1.1	< 0.2dB	400w PEP	UHF (F) to UHF (F)	1000v	6000A	DC350v ± 20%	Over 10,000M Ω	50Ω
SP1000PW	DC-1000 MHz	< 1.2	< 0.3dB	400w PEP	UHF (F) to UHF (M)	800v	6000A	DC350v ± 20%	Over 10,000M Ω	50Ω
SP3000	DC-3000 MHz	< 1.1	< 0.2dB	200w PEP	N (F) to N (F)	1000v	6000A	DC230v ± 20%	Over 10,000M Ω	50Ω
SP3000P	DC-3000 MHz	< 1.2	< 0.3dB	400w PEP	N (F) to N (M)	1000v	6000A	DC350v ± 20%	Over 10,000M Ω	50Ω
SP3000W	DC-3000 MHz	< 1.1	< 0.2dB	200w PEP	N (F) to N (F)	1000v	6000A	DC230v ± 20%	Over 10,000M Ω	50Ω

### NOTES:

I.W.D.V. = Impulse Wave Discharge Voltage I.W.D.C. = Impulse Wave Discharge Capacity I.W.R.D.C. = Impulse Wave Retention Discharge Capacity



#### SP1000:

- Dimensions: 2.5"W x 1.6"H x 0.8"D
- Weight: 0.18lbs.



#### SP3000:

- Dimensions: 3.1"W x 1.6"H x 0.8"D
- Weight: 0.25lbs.



#### SP1000PW:

- Water Proof
- Dimensions: 3.1"W x 2.2"H x 1.0"D
- Weight: 0.3lbs.



#### SP3000P:

- Dimensions: 3.0"W x 1.6"H x 0.8"D
- Weight: 0.25lbs.

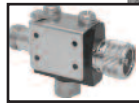

**Tip:** Use plate to easily wall mount the SP1000PW & SP3000W



#### SP3000W:

- Water Proof
- Dimensions: 3.1"W x 2.2"H x 1.0"D
- Weight: 0.35lbs.

## Radiation patterns and other important info

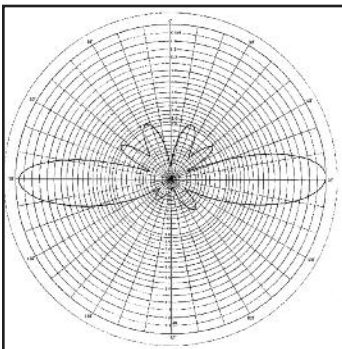

X50 450MHz

Radiation Pattern

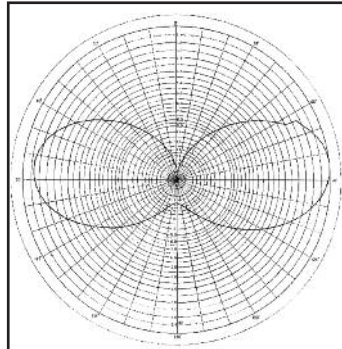

X50 147MHz

Radiation Pattern

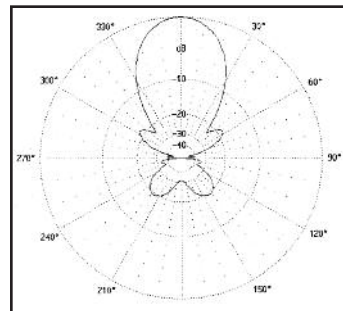

A430S10 432MHz

Radiation Pattern

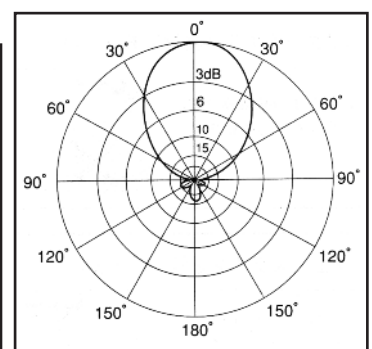

A502HB 51MHz

Radiation Pattern

### Radiation pattern explanation:

The X50 shows the vertical radiation pattern as if you were standing looking directly straight at the antenna.

The A430S10 and A502HB radiation patterns shows the pattern looking straight down at the antenna from a birds-eye view.

For more radiation patterns, and further explanation, please visit [www.diamondantenna.net](http://www.diamondantenna.net)

## More important info

### Connectors:



- Mates With -



PL-259 (UHF Male)

SO-239 (UHF Female)



- Mates With -



Type N (Male)

Type N (Female)

### Note:

Trying to mate the wrong connectors can result in broken center pins, and will void all warranty immediately.

For base applications you may order pre-made coaxial cable assemblies, or build your own custom cable assemblies. Available from **RF Parts Company**. Here is a power handling/Attenuation chart for a few popular cables used for base applications:

Frequency	LMR600 Pwr./Atten.	LDF4-50A Pwr./Atten.	F5J4-50B Pwr./Atten.	LMR400 Pwr./Atten.	Belden 9913F7 Pwr./Atten.	R6-213 Pwr./Atten.	LMR400 Ultraflex Pwr./Atten.	Bury Flex Pwr./Atten.	LMR240 Pwr./Atten.
10 MHz	-	11.35 / 0.205	10.14 / 0.318	-	2.68 / 0.6	2.67 / 0.55	-	-	-
30 MHz	5.51 / 0.4	6.51 / 0.357	5.79 / 0.557	3.33 / 0.7	2.0 / 0.8	1.8 / 1.2	2.77 / 0.8	2.0 / 0.8	1.49 / 1.3
50 MHz	4.24 / 0.5	5.02 / 0.463	4.45 / 0.724	2.57 / 0.9	1.46 / 1.1	1.12 / 1.3	2.14 / 1.1	1.6 / 1.1	1.15 / 1.7
150 MHz	2.41 / 1.0	2.85 / 0.815	2.51 / 1.285	1.47 / 1.5	0.85 / 1.7	0.60 / 2.8	1.22 / 1.8	0.85 / 1.7	0.66 / 3.0
220 MHz	1.97 / 1.2	2.34 / 0.994	2.05 / 1.574	1.20 / 1.9	0.77 / 1.9	0.45 / 3.5	1.00 / 2.2	0.77 / 2.1	0.54 / 3.7
450 MHz	1.35 / 1.7	1.61 / 1.447	1.39 / 2.314	0.83 / 2.7	0.5 / 3.0	0.30 / 5.2	0.69 / 3.3	0.5 / 3.0	0.38 / 5.3
900 MHz	0.93 / 2.5	1.11 / 2.097	0.95 / 3.396	0.58 / 3.9	0.36 / 4.7	0.20 / 7.6	0.48 / 4.7	0.36 / 4.4	0.26 / 7.6
1,500 MHz	0.70 / 3.3	0.84 / 2.771	0.71 / 4.543	0.44 / 5.1	-	-	0.36 / 6.2	-	0.20 / 9.9
2,500 MHz	0.52 / 4.4	0.63 / 3.685	0.53 / 6.129	0.33 / 6.8	-	-	0.28 / 8.1	-	0.18 / 12.9
Velocity (%)	87	88	81	85	85	66	85	82	84

Power Handling (kW, +40C, Sea Level, Continuous Duty Cycle.)      Low Duty Cycle Transmissions - for less than 50% duty cycle. Power rating may be doubled.      Attenuation is dB/100ft

## More Photos



K400S mount with an NR790 (discontinued)  
Photo Courtesy: Joe Mitterando, KC2UUZ

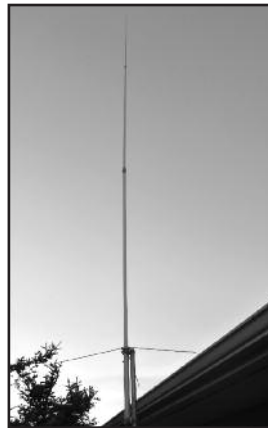

X510HDN Base Antenna  
Photo Courtesy: Wade Blake, N7LGK



X200A(left), D130J(right). Base Antennas  
Photo Courtesy: Mike Muranetz, VE6MM



SG7900 Series antenna  
Photo Courtesy: Mike Ayala, K4EQE



CP6AR Multiband Vertical Antenna  
Photo Courtesy: Ian Wilson, ZL10GX



K412 mount with an AZ507rsp  
Photo Courtesy: Joel Alderman, GOURK

# DIAMOND ANTENNA

[www.diamondantenna.net](http://www.diamondantenna.net)  
[facebook.com/diamondantenna](https://facebook.com/diamondantenna)

Distributed by RF Parts Company  
435 S. Pacific St. - San Marcos, CA 92078  
Ph: 770-614-7443 - Fx: 770-614-7480  
Email: [diamond@rfparts.com](mailto:diamond@rfparts.com)



## DIAMOND ANTENNA

Diamond Antennas are available through  
Authorized Diamond Antenna Dealers.

To find the Dealer nearest you,  
Call 770-614-7443 or visit

[www.diamondantenna.net/dealers.html](http://www.diamondantenna.net/dealers.html)