

DIAMOND ANTENNA

A502HB & A504HB

50 MHz Yagi Antennas

Specifications

Model:	A502HB	A504HB
Frequency MHz:	50-53 MHz	50-53 MHz
Gain:	6.3 dBi	10.8 dBi
Power Rating (P.E.P.):	400 W	400 W
Impedance (nominal):	50 Ohms	50 Ohms
Connector:	UHF	UHF
VSWR (nominal):	1.5:1	1.5:1
Element Phasing:	2	4
Front To Back Ratio:	15 dB	12 dB
Boom Length:	2.5 ft. (750mm)	10.66 ft. (3250mm)
Longest Element:	9.84 ft. (3000mm)	9.84 ft. (3000mm)
Driven Element diameter:		
Parasitic Elements diameter:		
Max. Mount diameter:		
Weight:	3.75 lbs. (1.7 kb)	7.7 lbs. (3.5 kg)
Warranty:	1 Year against defects in material or workmanship.	

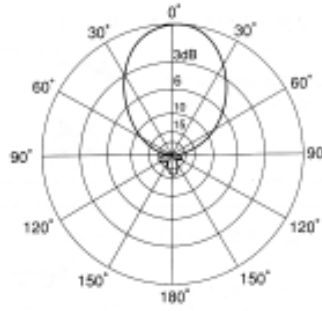

A502HB

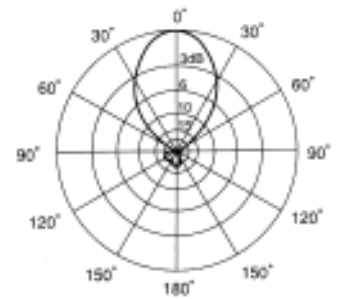

A504HB

WARNING

Do not install near electrical power lines. Fatal injuries or death may incur if antenna touches electrical power line. Do not tamper with matching network, as this will void all warranty.



Assembly Instructions

(1) Remove antenna from package and inspect contents to insure it is complete.

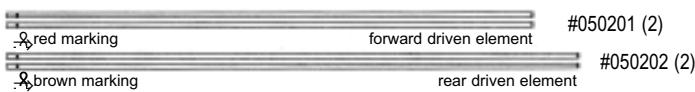

A502HB Parts List

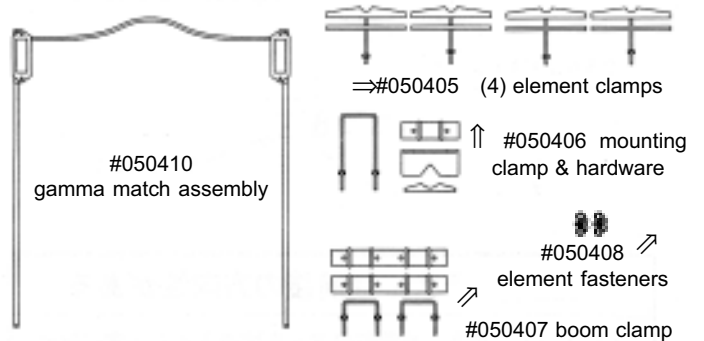
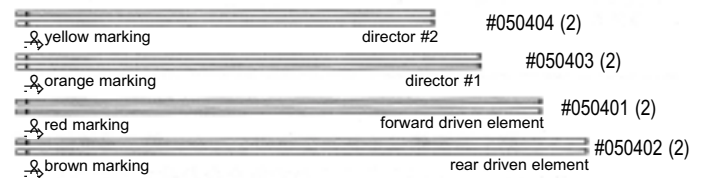
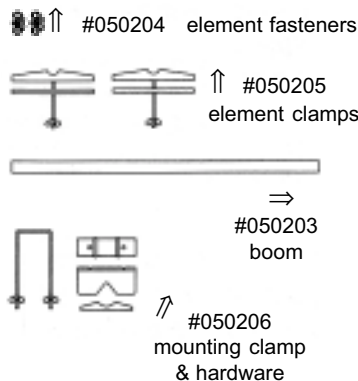

A504HB Parts List

(2) Loosen element clamp wing nuts on the Boom and adjust into correct mounting position. (A504HB Only ~ Clamp Boom sections together with proper mounting hardware.)



(3) Match elements to element clamps with similar color. Fit elements into mounting clamps so element hole fits through clamp extension. When elements are in proper position, tighten wing nut.

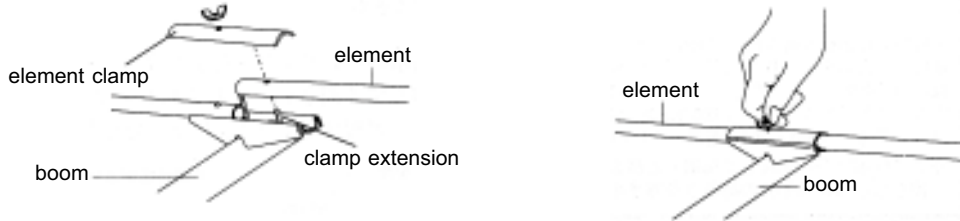

(4) Install gamma match assembly with red label into position matching red label on boom. Match the hole on Boom with extension on gamma match assembly and fasten wing nut. Do the same to the other side of gamma match assembly. When in place, use zip ties to secure cable on boom.

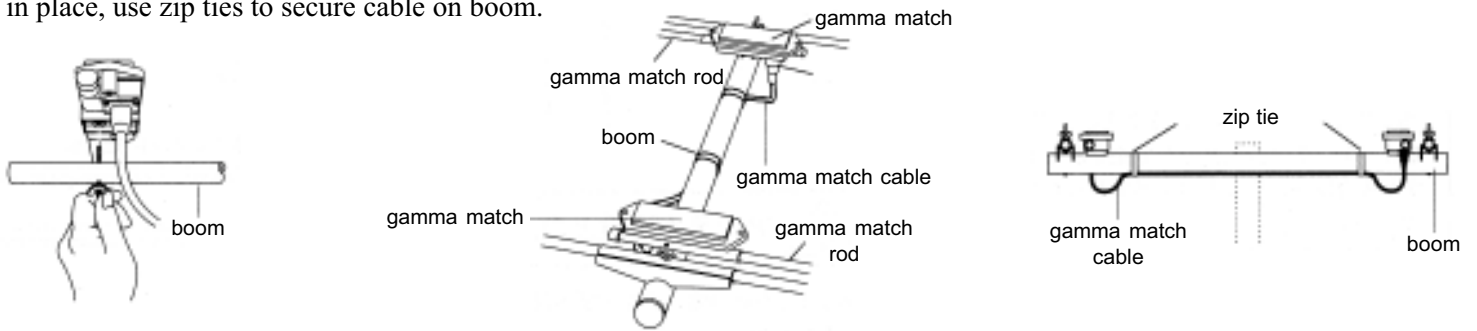

(5) Install element fasteners at perforations on gamma match rod. Lightly fasten into position until final tuning adjustment.

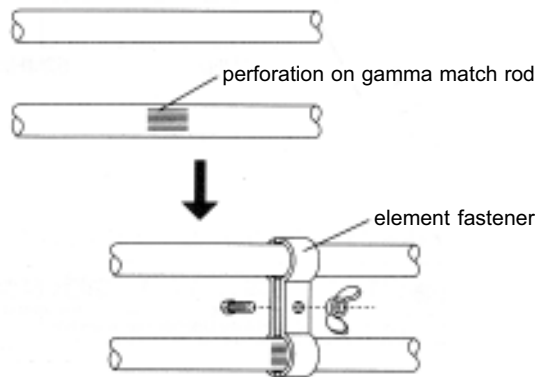

(6) Install mounting clamp to boom and prepare for installation on mast.

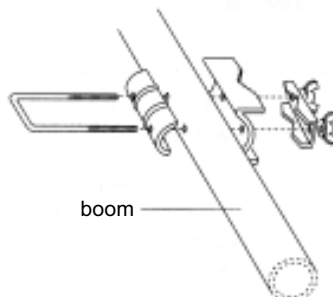

Tuning Antenna

With quality VSWR meter, check VSWR for proper antenna tuning. If tuning adjustments are required, loosen element fasteners and slide in similar increments until desired center frequency is obtained. Moving element fasteners closer to boom lowers center frequency and moving them away from boom raises center frequency.

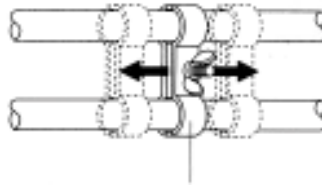

Before Final Installation

- A. Use coax seal to protect both antenna connection and cable connection from weather.
- B. Spray antenna and mounting hardware with non-conductive acrylic paint to increase the life of antenna and mounting hardware.
- C. Recommend using removable Loctite Threadlocker #242 or similar product to insure proper fastening of wing nuts.

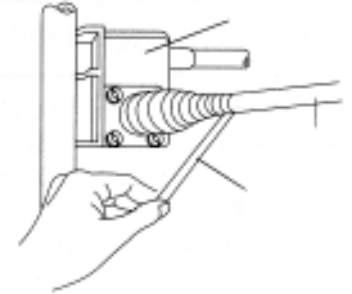

Nominal VSWR

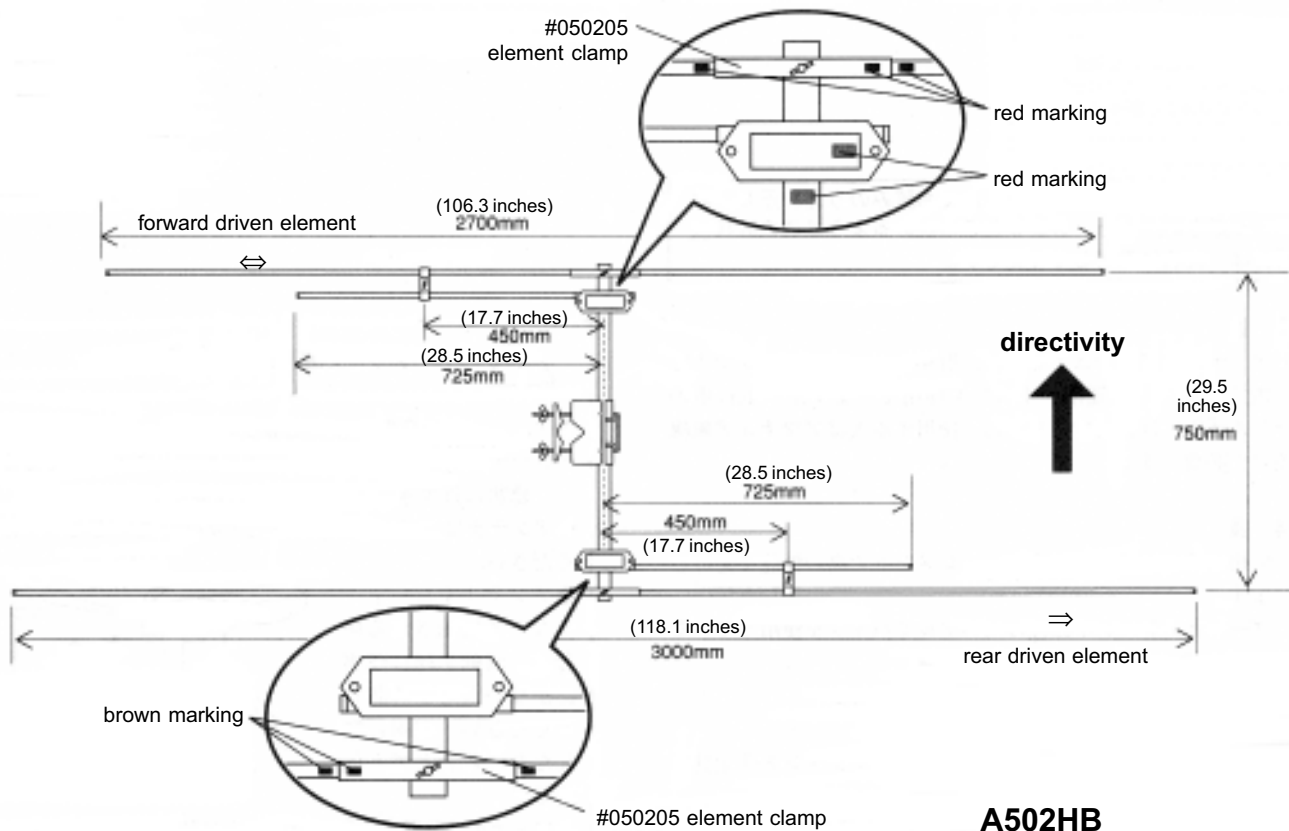
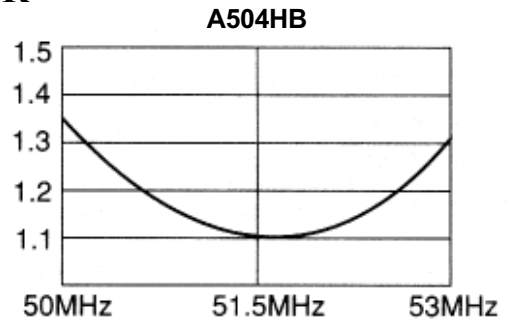
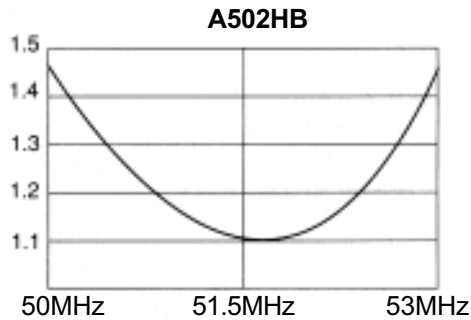

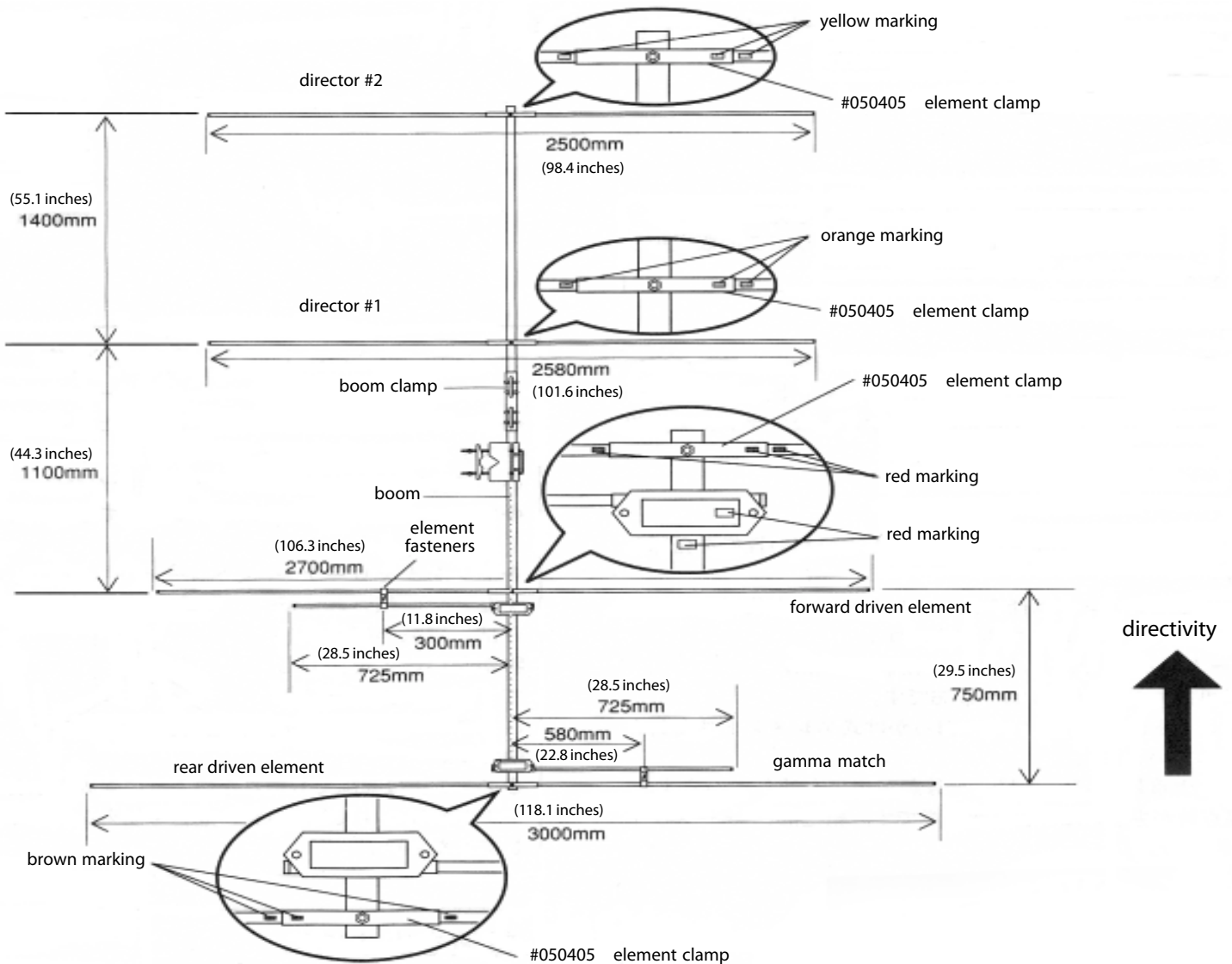

A504HB

WARNING!

Any tampering, cutting, or attempted adjustment of this antenna beyond our recommendations may void all warranty. If you have any questions, please call our Customer Service Department at 760-744-0900.

DIAMOND ANTENNA Products are distributed by RF PARTS COMPANY
 435 S. Pacific Street • San Marcos, CA 92078 • (770) 614-7443
www.diamondantenna.net